

# DENTAL INSTRUMENTS

High Quality  
Instruments

Extraction Sets  
Extracting Forceps  
Root Elevators  
Bone Rongeurs  
Orthodontic Pliers  
Scalers  
Impression Trays



Manufacturers & Exporters Of  
Surgical, Dental & Beauty Instruments



ISO 9001  
ISO 13485  
CERTIFIED

  
**V A R C O**  
— INTERNATIONAL —



Varco International  
Gohad Pur Sialkot-Pakistan.



0092-52-4261213



0092-321-6186756



Sherazahmadpak30@gmail.com



varcointl@gmail.com



info@varcointl.com



www.varcointl.com



*We present this CATALOGUE with a hope that it would be an excellent guide to all over promoters and Dental professionals the world over.*

*We endeavor to present in this CATALOGUE a modern range of instruments to the trade and medical professionals in order to achieve the highest result.*

*We are the located in the center of the city which is known the world over for this profession having at our disposal expert crafted whose skilled technique and traditional approach towards modern surgery makes all the possibilities to acclaim us quality instruments producers.*

*We are grateful for the loyal support given to us by our promoters who have been selling our Stainless Steel Dental Instruments in their market with pride and honor.*

*We pledge to serve more in the years ahead to our quality minded promoters with much more higher standard and correct design of the instruments.*

*We also welcome our enquiries for the instruments not listed in This CATALOGUE both in Dental instruments.*

*It is our earnest desire to maintain our present price but due to the present universal economic condition which are beyond our control, all prices are subjected to change without any notice.*



Set - 01

**KIT ROOT ELEVATORS**  
(Complete Set of 6 Pcs.)

- |    |                       |         |
|----|-----------------------|---------|
| 01 | ROOT ELEVATORS APICAL | Fig.301 |
| 02 | ROOT ELEVATORS APICAL | Fig.302 |
| 03 | ROOT ELEVATORS APICAL | Fig.303 |
| 04 | ROOT ELEVATORS SELDIN | Fig.34S |
| 05 | ROOT ELEVATORS CRYER  | Fig.44  |
| 06 | ROOT ELEVATORS CRYER  | Fig.45  |



Set - 02

**EXTRACTION AND ORAL SURGERY**  
(Complete Set of 9Pcs.)

- |    |                          |          |
|----|--------------------------|----------|
| 01 | EXTRACTING FORCEPS       | Fig. 67A |
| 02 | EXTRACTING FORCEPS       | Fig. 51A |
| 03 | EXTRACTING FORCEPS       | Fig. 33  |
| 04 | EXTRACTING FORCEPS       | Fig. 79  |
| 05 | ROOT ELEVATORS FLOHR     | Fig. 20  |
| 06 | ROOT ELEVATORS FLOHR     | Fig. 238 |
| 07 | ROOT ELEVATORS FLOHR     | Fig. 239 |
| 08 | MAYO HEGAR NEEDLE HOLDER | 16 cm    |
| 09 | MATHIEU NEEDLE HOLDER    | 14 cm    |



● ● ● Extraction Set



Set - 03

INSTRUMENTS SET FOR EXTRACTION  
(Complete Set of 9 Pcs.)

- |    |                       |          |
|----|-----------------------|----------|
| 01 | EXTRACTING FORCEPS    | Fig. 67A |
| 02 | EXTRACTING FORCEPS    | Fig. 51A |
| 03 | EXTRACTING FORCEPS    | Fig. 33  |
| 04 | EXTRACTING FORCEPS    | Fig. 79  |
| 05 | ROOT ELEVATORS FLOHR  | Fig. 20  |
| 06 | ROOT ELEVATORS FLOHR  | Fig. 238 |
| 07 | ROOT ELEVATORS FLOHR  | Fig. 239 |
| 08 | ROOT ELEVATORS WINTER | Fig. 320 |
| 09 | ROOT ELEVATORS WINTER | Fig. 321 |



Set - 04

INSTRUMENTS SET FOR EXTRACTION  
(Complete Set of 8 Pcs.)

- |    |                    |          |
|----|--------------------|----------|
| 01 | EXTRACTING FORCEPS | Fig. 1   |
| 02 | EXTRACTING FORCEPS | Fig. 17  |
| 03 | EXTRACTING FORCEPS | Fig. 18  |
| 04 | EXTRACTING FORCEPS | Fig. 79  |
| 05 | EXTRACTING FORCEPS | Fig. 67A |
| 06 | EXTRACTING FORCEPS | Fig. 51A |
| 07 | EXTRACTING FORCEPS | Fig. 13  |
| 08 | EXTRACTING FORCEPS | Fig. 22  |





**INSTRUMENTS SET FOR EXTRACTION**  
(Complete Set of 8 Pcs.)

- 01 EXTRACTING FORCEPS Fig. 1
- 02 EXTRACTING FORCEPS Fig. 17
- 03 EXTRACTING FORCEPS Fig. 18
- 04 EXTRACTING FORCEPS Fig. 79
- 05 EXTRACTING FORCEPS Fig. 67A
- 06 EXTRACTING FORCEPS Fig. 51A
- 07 EXTRACTING FORCEPS Fig. 13
- 08 EXTRACTING FORCEPS Fig. 22



**EXTRACTION FORCEPS FOR CHILDREN**  
(Complete Set of 10 Pcs.)

- 01 EXTRACTING FORCEPS FINO Fig. 37
- 02 EXTRACTING FORCEPS FINO Fig. 39
- 03 EXTRACTING FORCEPS FINO Fig. 39L
- 04 EXTRACTING FORCEPS FINO Fig. 39R
- 05 EXTRACTING FORCEPS FINO Fig. 51S
- 06 EXTRACTING FORCEPS FINO Fig. 13S
- 07 EXTRACTING FORCEPS FINO Fig. 30S
- 08 EXTRACTING FORCEPS FINO Fig. 33S
- 09 EXTRACTING FORCEPS FINO Fig. 22S
- 10 EXTRACTING FORCEPS FINO Fig. 38



● ● ● Extraction Set



Set - 07

**INSTRUMENTS SET FOR EXTRACTING FORCEPS**  
(Complete Set of 10 Pcs.)

- |    |                    |          |
|----|--------------------|----------|
| 01 | EXTRACTING FORCEPS | Fig. 2   |
| 02 | EXTRACTING FORCEPS | Fig. 7   |
| 03 | EXTRACTING FORCEPS | Fig. 51A |
| 04 | EXTRACTING FORCEPS | Fig. 17  |
| 05 | EXTRACTING FORCEPS | Fig. 18  |
| 06 | EXTRACTING FORCEPS | Fig. 67A |
| 07 | EXTRACTING FORCEPS | Fig. 13  |
| 08 | EXTRACTING FORCEPS | Fig. 33  |
| 09 | EXTRACTING FORCEPS | Fig. 22  |
| 10 | EXTRACTING FORCEPS | Fig. 79  |



Set - 08

**EXTRACTING FORCEPS SET FOR CHILDREN KLEIN PATTERN**  
(Complete Set of 7 Pcs.)

- |    |                             |          |
|----|-----------------------------|----------|
| 01 | EXTRACTING FORCEPS CHILDREN | Fig. 5   |
| 02 | EXTRACTING FORCEPS CHILDREN | Fig. 6   |
| 03 | EXTRACTING FORCEPS CHILDREN | Fig. 7   |
| 04 | EXTRACTING FORCEPS CHILDREN | Fig. 137 |
| 05 | EXTRACTING FORCEPS CHILDREN | Fig. 139 |
| 06 | EXTRACTING FORCEPS CHILDREN | Fig. 3   |
| 07 | EXTRACTING FORCEPS CHILDREN | Fig. 51S |



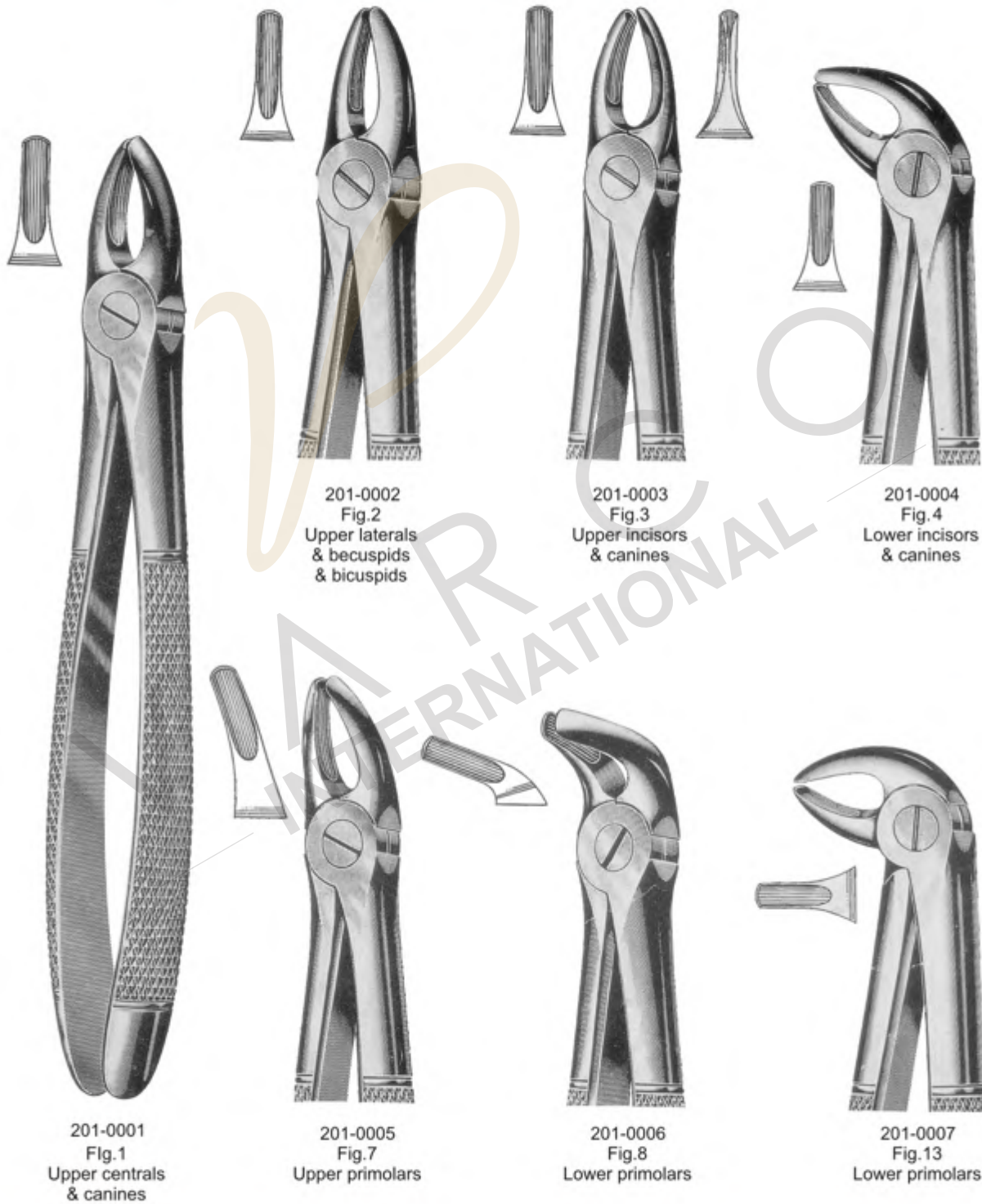

●●● EXTRACTING FORCEPS ENGLISH PATTERN







201-0015  
Fig.23  
Right lower molars



201-0016  
Fig.24  
Left lower molars



201-0017  
Fig.29  
Upper root & incisors

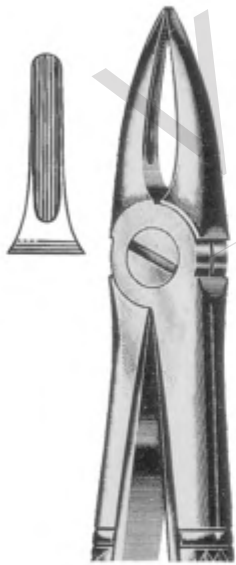

201-0018  
Fig.29N  
Roots of upper incisors

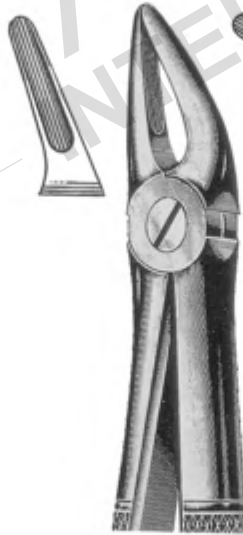

201-0019  
Fig.30  
Upper roots & incisors

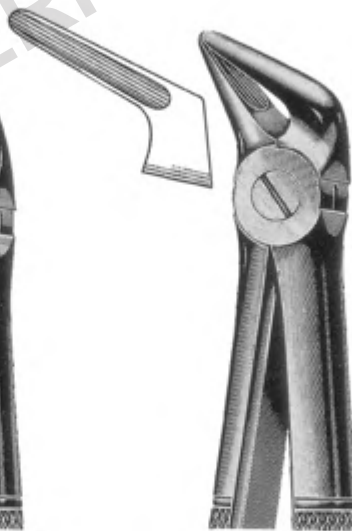

201-0020  
Fig.31  
Lower roots



201-0021  
Fig.32  
Lower molars

## ●●● EXTRACTING FORCEPS ENGLISH PATTERN



201-0022  
Fig.33  
Lower roots



201-0023  
Fig.33A  
Lower roots

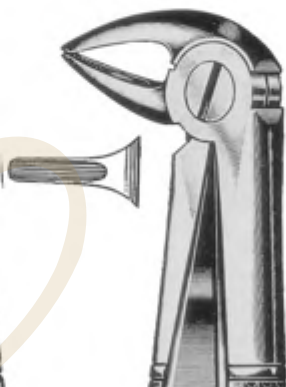

201-0024  
Fig.33C  
Lower roots



201-0025  
Fig.33M  
Lower roots with long beak



201-0026  
Fig.41  
Upper roots

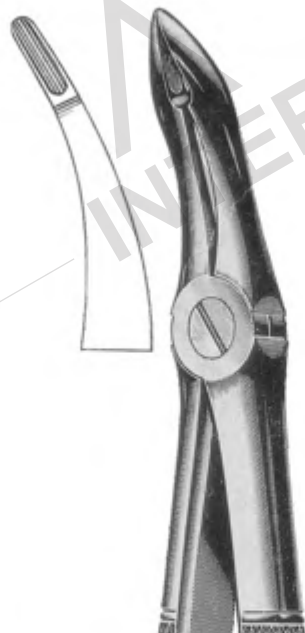

201-0027  
Fig.44  
Upper roots

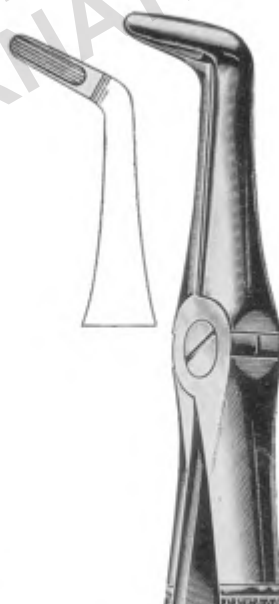

201-0028  
Fig.45  
Lower roots

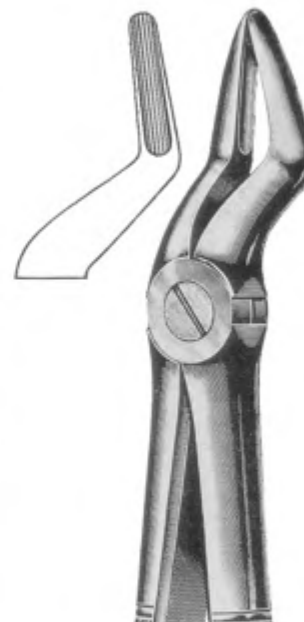

201-0029  
Fig.51  
Upper roots

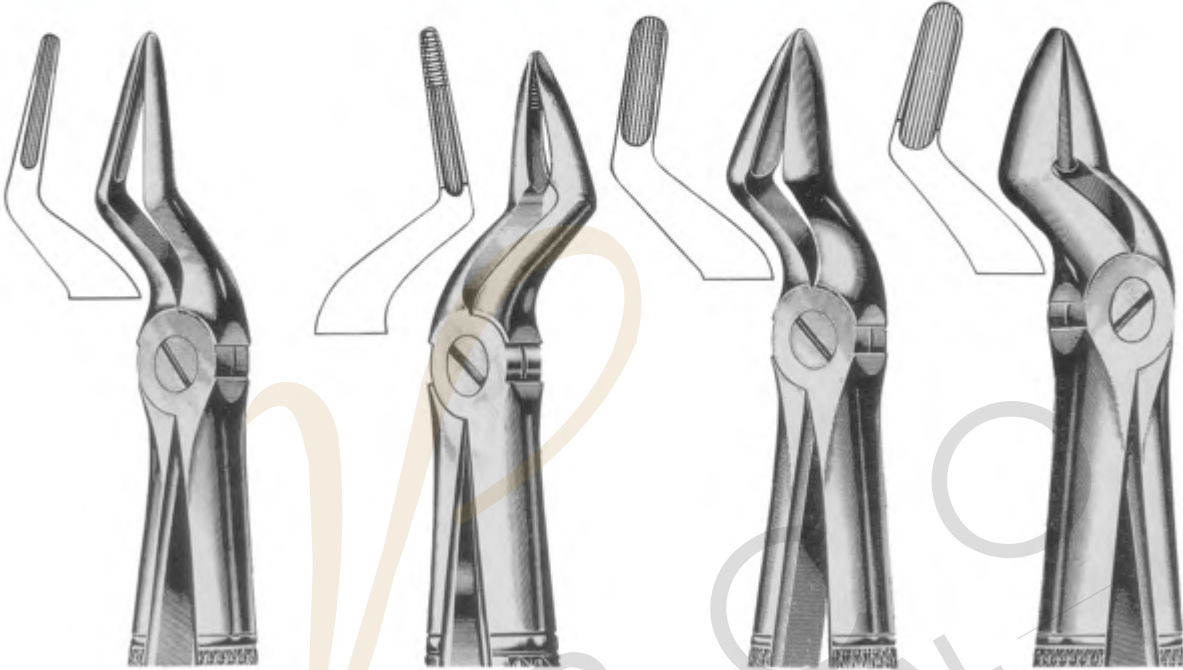

201-0030  
Fig.51A  
Upper roots narrow beak

201-0031  
Fig.51C  
Upper roots

201-0032  
Fig.52  
Upper roots & canines  
with wider beak

201-0033  
Fig.52A  
Upper teeth & resection

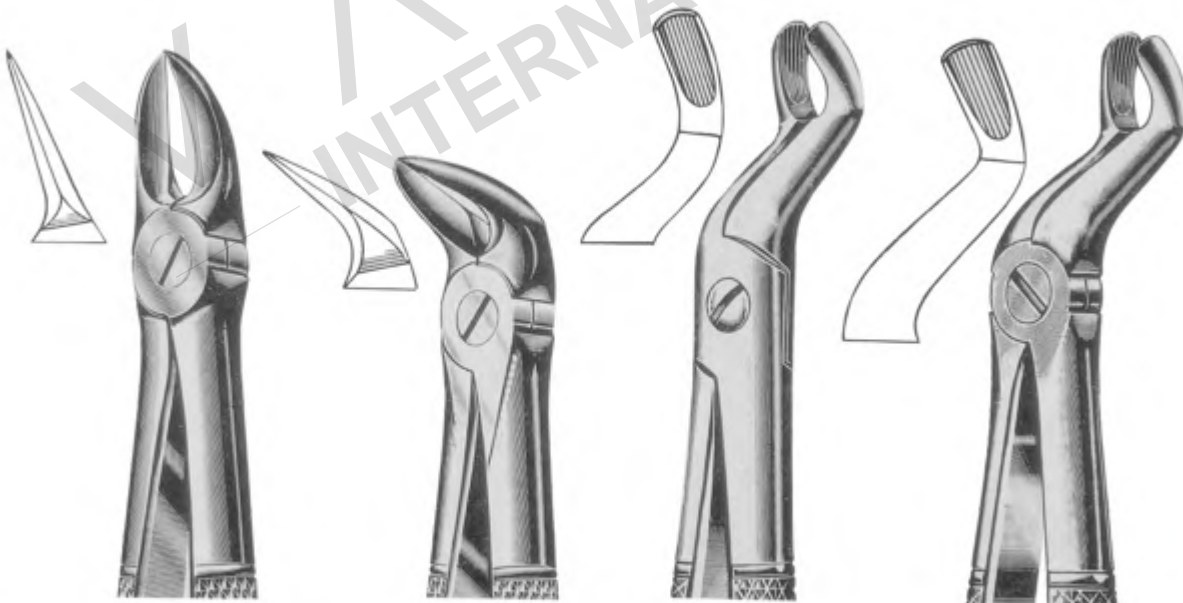

201-0034  
Fig.55  
Separating upper molars roots

201-0035  
Fig.56  
Separating lower molars roots

201-0036  
Fig.67  
Upper wisdoms

201-0037  
Fig.67A  
Upper wisdoms

●●● EXTRACTING FORCEPS ENGLISH PATTERN

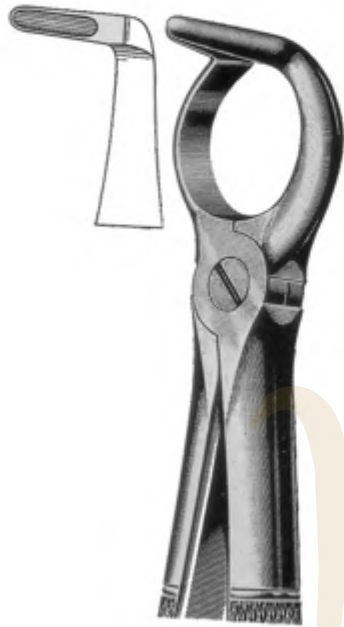

201-0038  
Fig. 68  
Lower roots

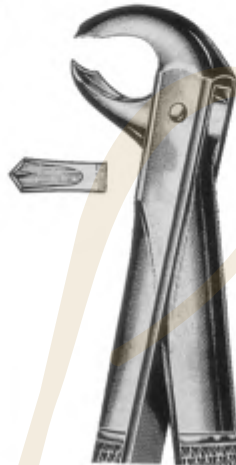

201-0039  
Fig. 73  
Lower molars (hawk's bill)



201-0040  
Fig. 74  
Lower incisors & roots



201-0041  
Fig. 74M  
Lower incisors & roots



201-0042  
Fig. 74N  
Lower incisors & roots



201-0043  
Fig. 75  
Lower premolars & canines



201-0044  
Fig. 76  
Upper roots



201-0045  
Fig. 76N  
Upper roots  
Narrow break



201-0046  
Fig.79  
Lower wisdoms

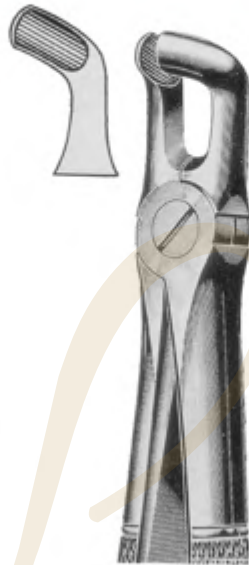

201-0047  
Fig.79A  
Lower wisdoms



201-0048  
Fig.86A  
Lower molars



201-0049  
Fig. 86B  
Lower molars



201-0050  
Fig.86C  
Lower molars

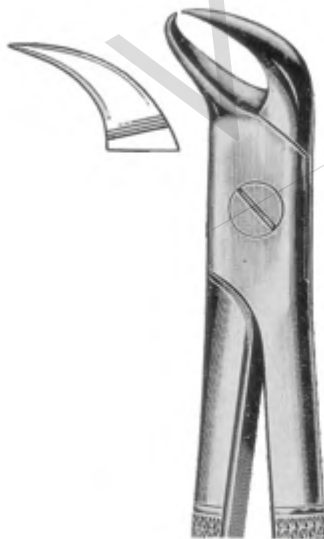

201-0051  
Fig.87  
Cowhorn beak



201-0052  
Fig.89  
Right upper molars



201-0053  
Fig.9  
Left upper molars

●●● EXTRACTING FORCEPS ENGLISH PATTERN

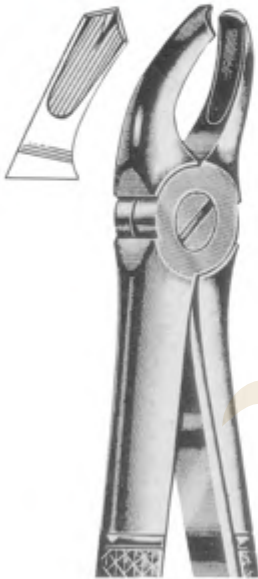

201-0054  
Fig.94  
Right upper molars

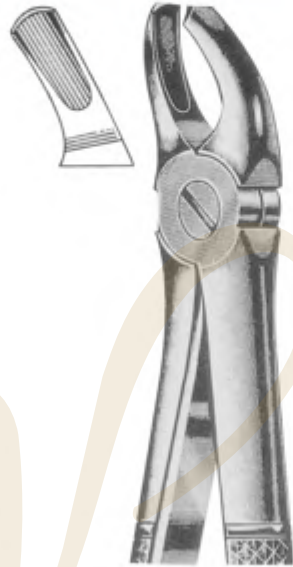

201-0055  
Fig.95  
Left upper molars

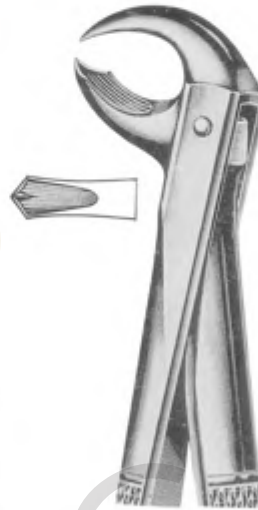

201-0056  
Fig.99  
Lower molars  
(broken-down)



201-0057  
Fig.99 1/4  
Lower molars  
(broken-down)

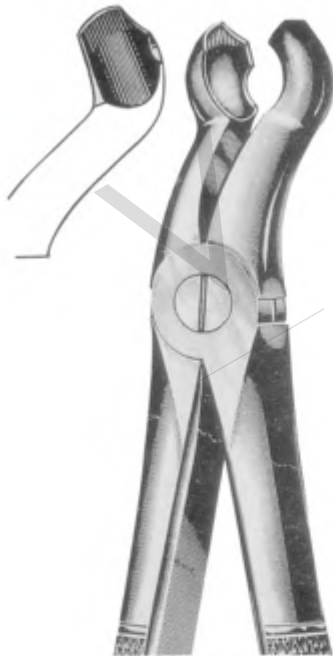

201-0058  
Fig.121  
Upper wisdoms



201-0059  
Fig.136  
Upper centrals  
& roots



201-0060  
Fig.137  
Lower centrals  
& roots

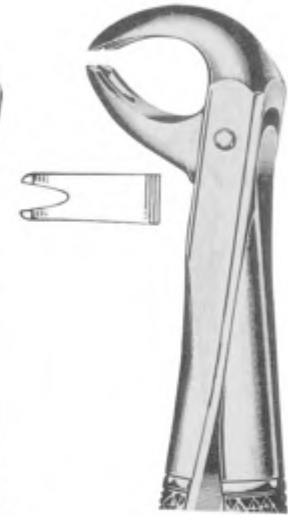

201-0061  
Fig.167  
Universal patten  
for lower teeth  
molars & premolars

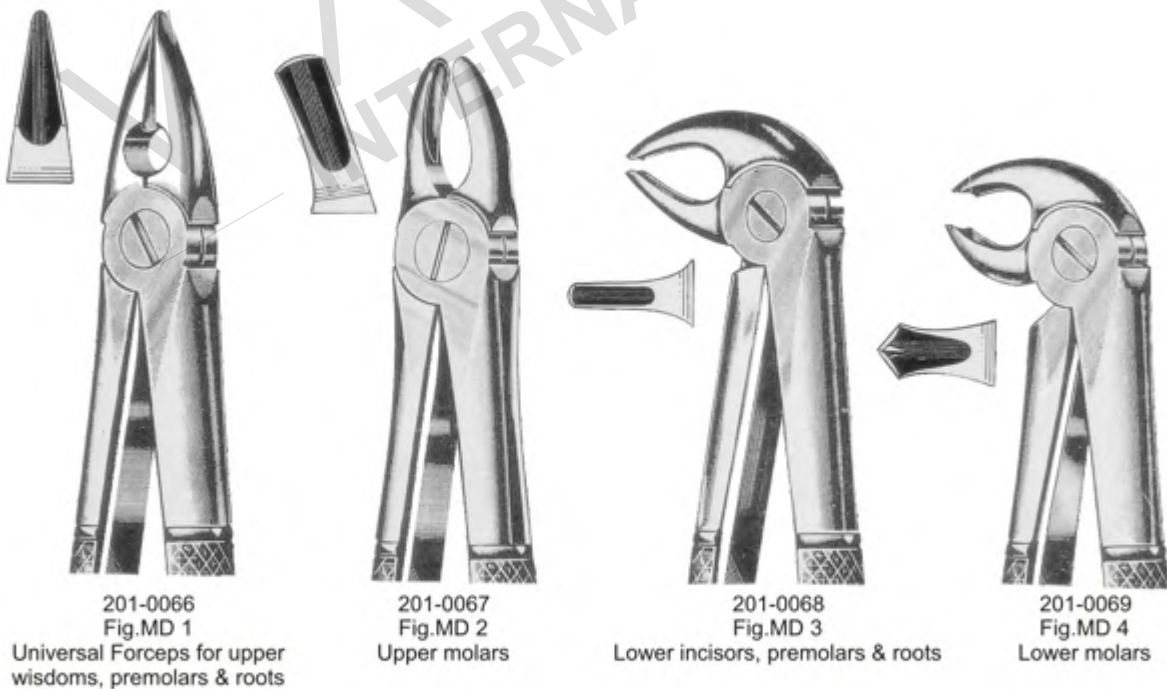

●●● EXTRACTING FORCEPS ENGLISH PATTERN



201-0070

Fig.37

Children's upper incisors & canines

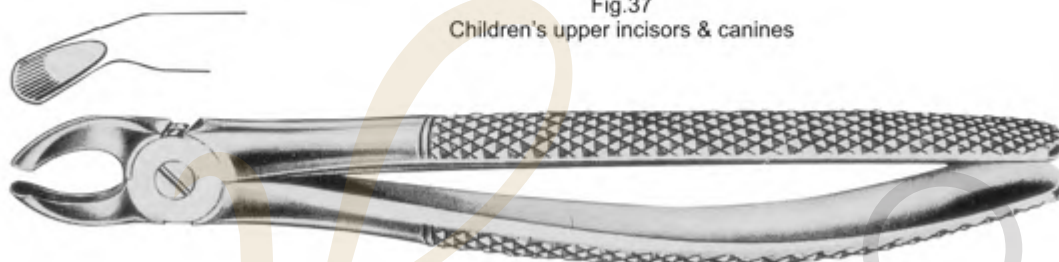

201-0071

Fig.39

Children's upper molars & universal

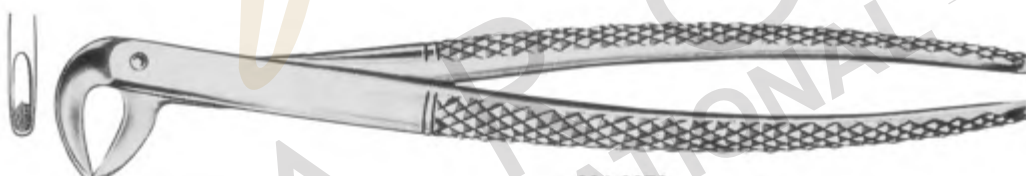

201-0072

Fig.123

Children's lower teeth universal



201-0073

Fig.138

Children's upper universal & roots

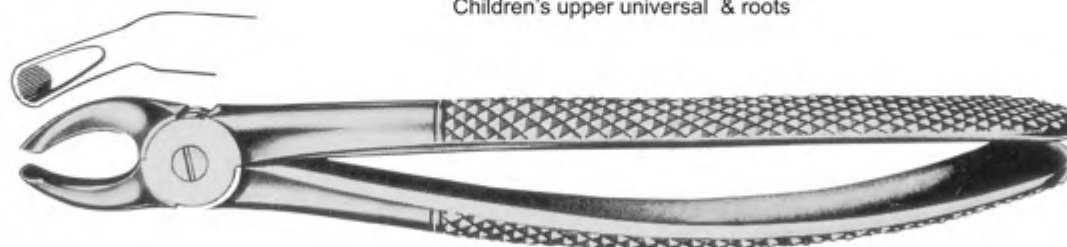

201-0074

Fig.157

Children's upper molars universal



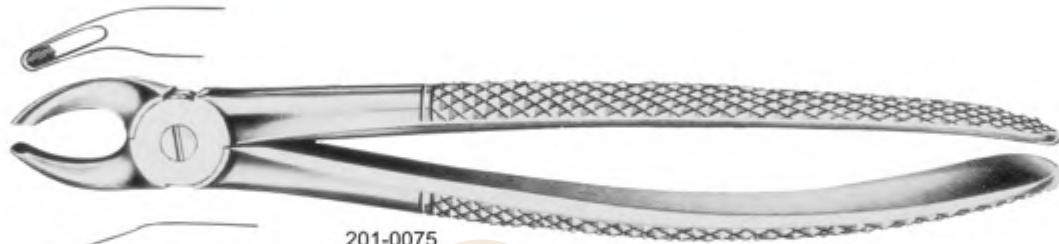

201-0075

Fig.158

Children's upper teeth molars universal

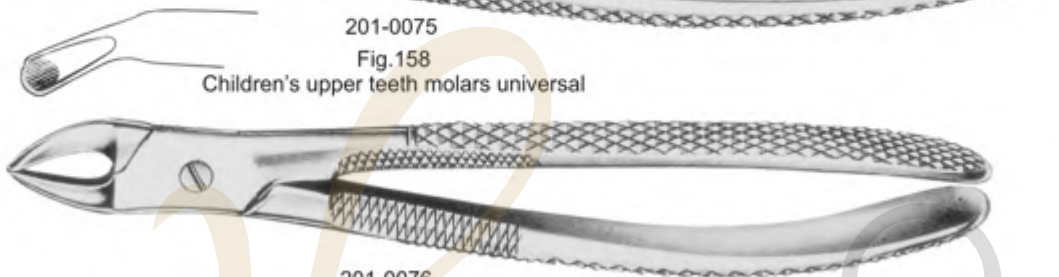

201-0076

Fig.159

Children's lower molars universal

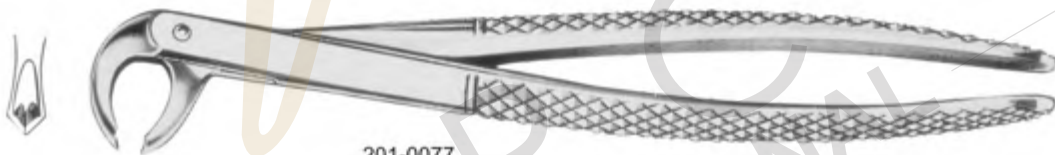

201-0077

Fig.160

Children's upper lower universal (hawk's bill)

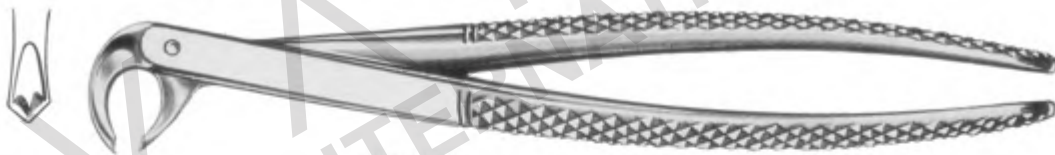

201-0078

Fig.161

Children's lower & roots

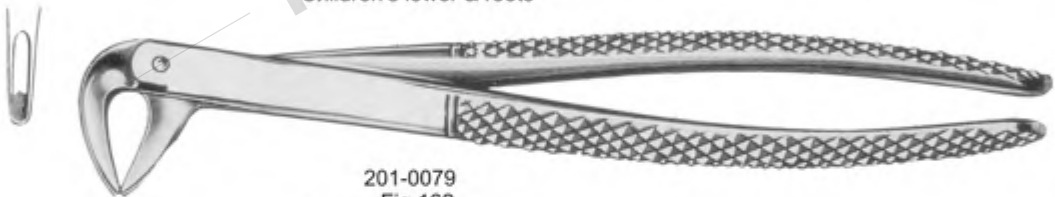

201-0079

Fig.162

Children's upper centrals

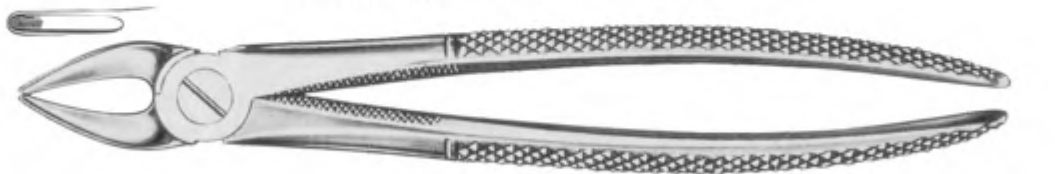

201-0080

Fig.163

Children's upper centrals

## ●●● EXTRACTING FORCEPS FOR CHILDREN'S WITH SPRING



201-0081  
Fig. 3  
Upper molars



201-0082  
Fig. 5  
Lower incisors



201-0083  
Fig. 6  
Lower molars



201-0084  
Fig. 7  
Lower roots



201-0085  
Fig. 137  
Upper incisors  
& canines



201-0086  
Fig. 139  
Upper premolars



201-0087  
Fig. 51S  
Upper roots

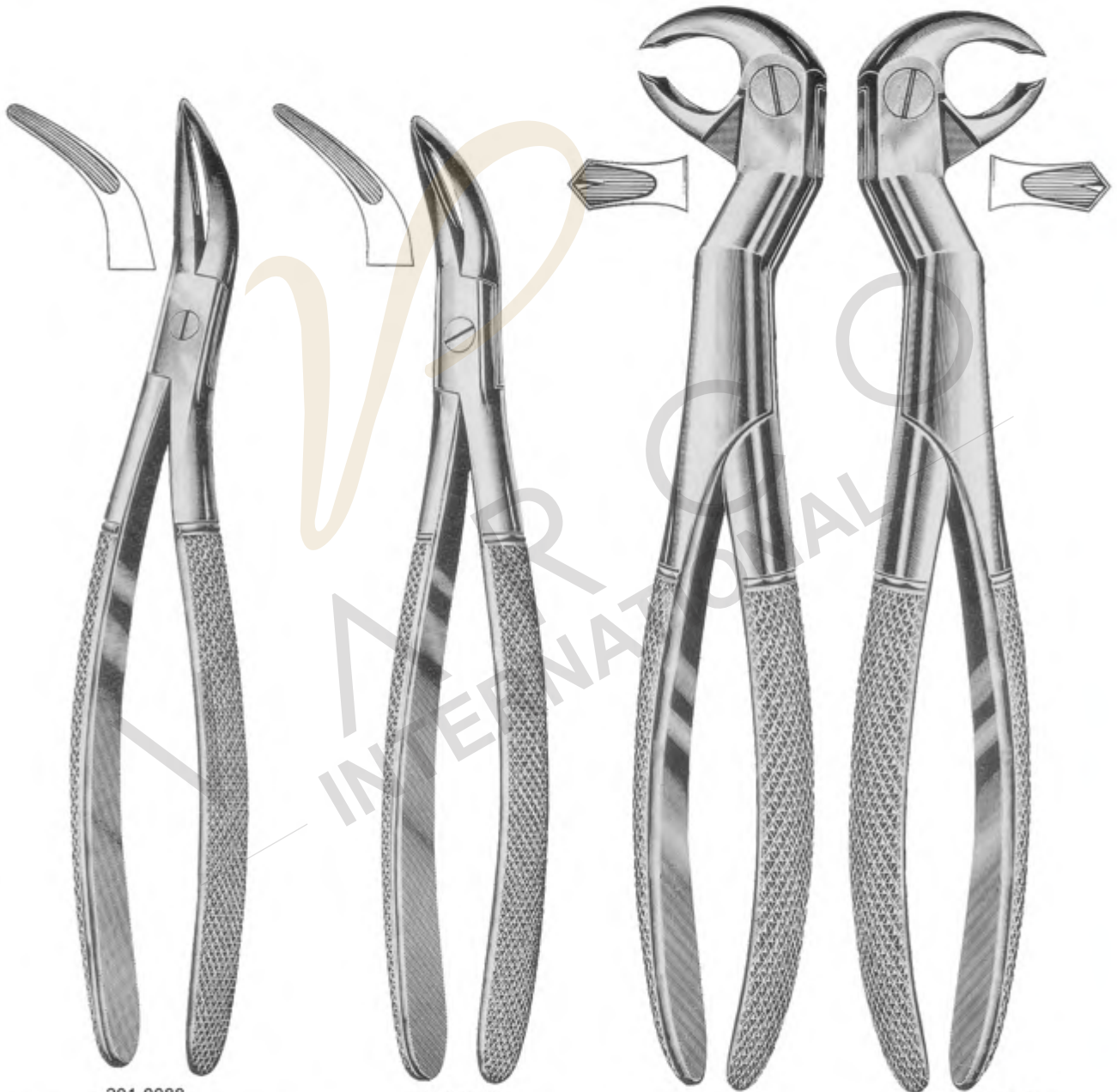

201-0088  
Universal pattern for upper teeth

201-0089  
Universal pattern for lower teeth

201-0090  
Fig. 22 1/2 L  
Left lower wisdoms & molars

201-0091  
Fig. 22 1/2 R  
Right lower wisdoms & molars

●●● EXTRACTING FORCEPS AMERICAN PATTERN

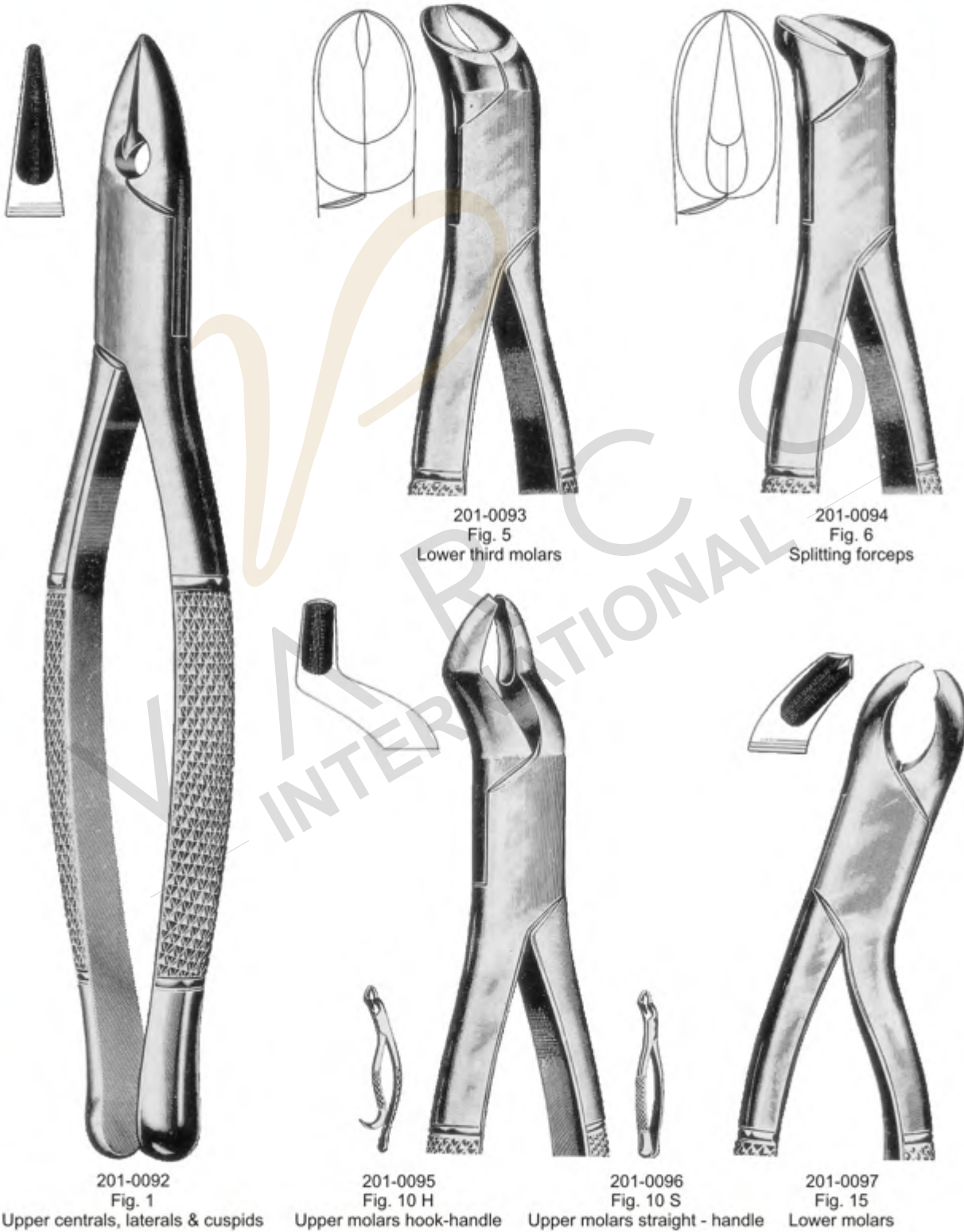



201-0098  
Fig. 16 S  
Lower molars children's



201-0099  
Fig. 16  
Lower molars (cow-horn beak)  
201-0100  
Fig.16 SK



201-0101  
Fig. 17  
Lower molars  
201-0102  
Fig.17 SK



201-0103  
Fig. 18L  
Upper molars left side  
201-0104  
Fig.18L SK



201-0105  
Fig. 18R  
Upper molars right side  
201-0106  
Fig.18R SK

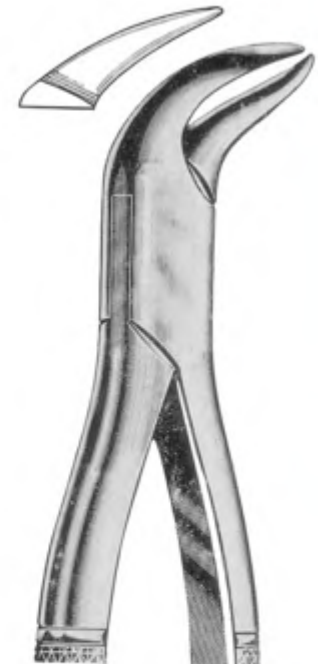

201-0107  
Fig. 23  
Lower molars (cow-horn beak)  
201-0108  
Fig.23 SK

●●● EXTRACTING FORCEPS AMERICAN PATTERN



201-0109  
Fig. 32  
Upper molars & pre molars  
strong beak  
201-0110  
Fig. 32 SK

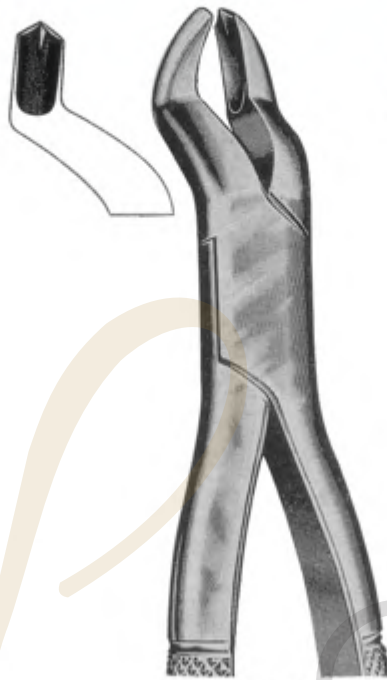

201-0111  
Fig. 53 L  
Upper molars left side  
201-0112  
Fig. 53 L SK



201-0113  
Fig. 53 R  
Upper molars right side  
201-0114  
Fig. 53R SK



201-0115  
Fig. 62  
Universal forceps  
for upper teeth & roots  
201-0116  
Fig. 62 SK



201-0117  
Fig. 65  
Upper Incisors & root  
201-0118  
Fig. 65 SK



201-0119  
Fig. 69  
Fragments & small roots  
Upper & lower  
201-0120  
Fig. 69 SK

AMERICAN PATTERN



201-0121  
Fig. 88 R  
Right upper molars  
201-0122  
Fig. 88 R SK



201-0123  
Fig. 88L  
Left upper molars  
201-0124  
Fig. 88L SK



201-0125  
Fig. 99C  
Upper Premolars,  
Molar & incisors  
201-0126  
Fig. 99C SK

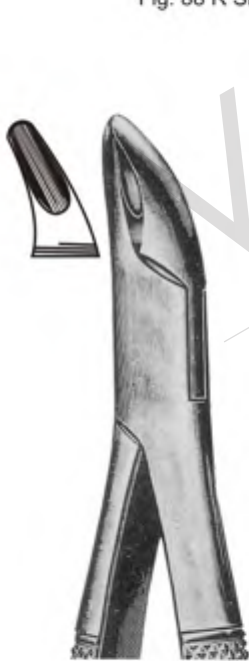

201-0127  
Fig. 101  
Universal forceps  
for premolars  
201-0128  
Fig. 101 SK

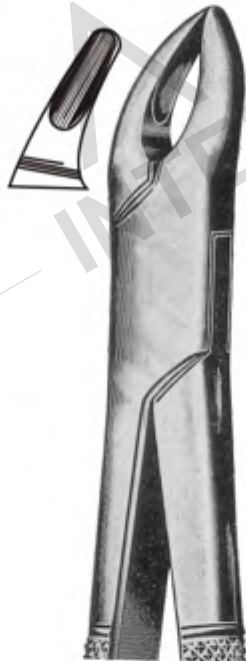

201-0129  
Fig. 150  
Upper premolars,  
incisors & roots  
201-0130  
Fig. 150 SK



201-0131  
Fig. 150A  
Upper premolars incisors & roots  
201-0132  
Fig. 150A SK



201-0133  
Fig. 150S  
Upper premolars incisors & roots  
for children  
201-0134  
Fig. 150 SK

●●● EXTRACTING FORCEPS AMERICAN PATTERN



201-0135  
Fig. 151  
Lower premolars, incisors & roots  
201-0136  
Fig. 151 SK

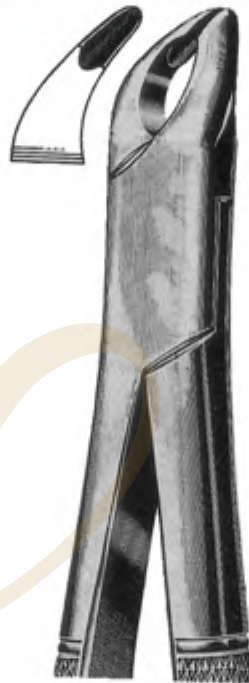

201-0137  
Fig. 151A  
Lower premolars, incisors & roots  
201-0138  
Fig. 151A SK



201-0139  
Fig. 151S  
Lower premolars, incisors & roots  
for children's  
201-0140  
Fig. 151 SK

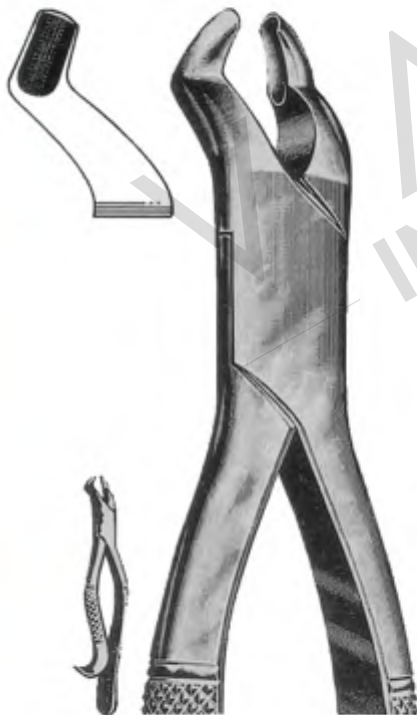

201-0141  
Fig. 210H  
Upper wisdoms with  
hook handle  
201-0142  
Fig. 210H SK

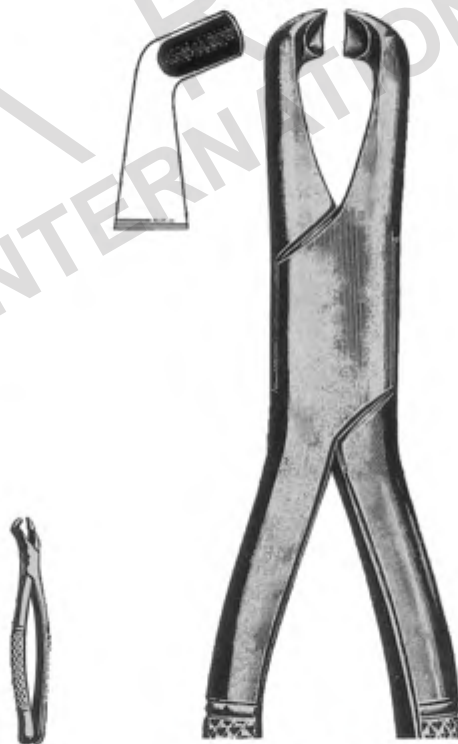

201-0143  
Fig. 210S  
Upper wisdoms with  
straight handle  
201-0144  
Fig. 210 SK

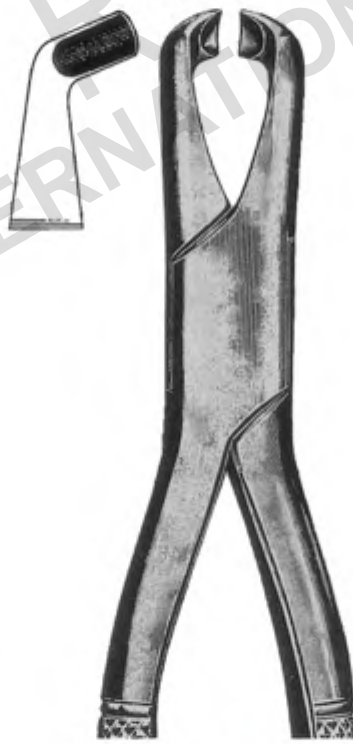

201-0145  
Fig. 222  
Lower wisdoms  
201-0146  
Fig. 222 SK



201-0147  
Fig. 286  
Upper roots, premolars & incisors  
20-0148  
Fig. 286 SK



**EXTRACTING FORCEPS** EXTRACTION TWEEZER ●●●



201-0149  
Fig. 1  
Lower roots



201-0150  
Fig. 2  
Upper roots



201-0151  
Fig. 44  
201-0152  
Fig. 44 SK



201-0153  
Albrecht 16cm



201-0154  
Albrecht 16cm

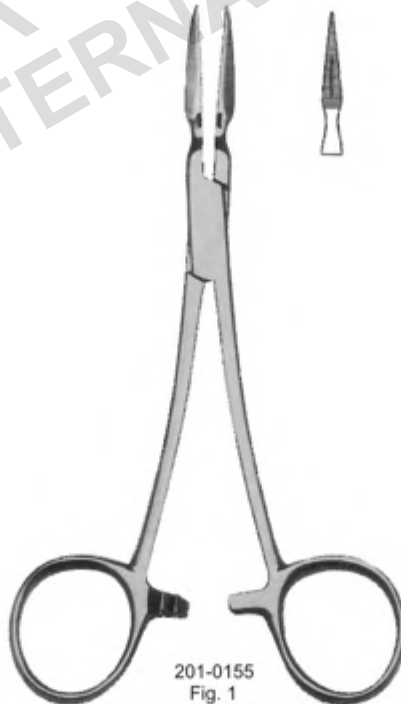

201-0155  
Fig. 1  
Root fragments



201-0156  
Fig. 2  
Root fragments

## ●●● PLIERS FOR ORTHODONTICS & PROSTHETICS

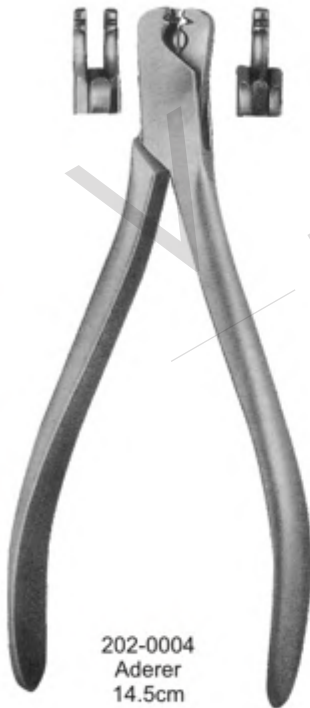

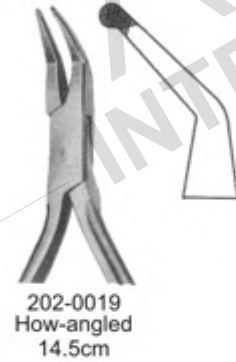

## ●●● PLIERS FOR ORTHODONTICS & PROSTHETICS



202-0023  
Peeso  
13.5cm

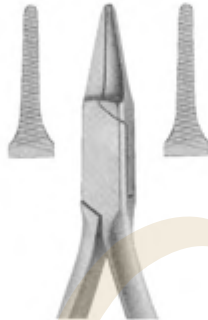

202-0024  
Peeso  
13.5cm



202-0025  
14cm



202-0026  
Langenbeck  
14cm



202-0027  
Jarabak  
14cm



202-0028  
Bending Plier  
13cm



202-0029  
Angle  
12.5cm



202-0030  
Andresen  
13cm



202-0031  
Bending Plier  
13.5cm



202-0032  
Schwarz  
13.5cm

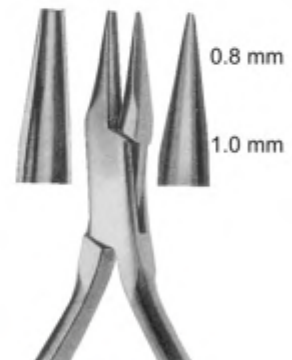

202-0033  
Fischer  
13cm



202-0034  
Aderer  
12cm



202-0035  
Aderer-Heavy  
12cm



202-0036  
Tweed  
14.5cm



202-0037  
O'Brien  
13.5cm



202-0038  
Wire bending pliers  
12.5cm



202-0039  
Adams  
12.5cm



202-0041  
Young  
14cm



202-0039  
Adams  
12.5cm



202-0040  
Frevert  
12.5cm



202-0042  
Clasp forming  
14cm

## ●●● PLIERS FOR ORTHODONTICS & PROSTHETICS



202-0043  
Hard Wire Cutter  
5 1/2" (14 cm)



202-0044  
Arch Forming Plier  
5 1/2" (14 cm)



202-0045  
Medium Size Bending Pliers  
5 1/2" (14 cm)



202-0046  
Aderer Pliers  
5 1/2" (14 cm)



202-0047  
Wire Bending Plier  
5 1/2" (14 cm)



202-0048  
Round & Concave Plier  
5 1/2" (14 cm)



202-0049  
Aderer Pliers  
with narrow standing points,  
for bending wires up to  $\varnothing$  0.5mm,  
disinfectable, sterilizable  
4 3/4" (12cm)



202-0050  
Aderer Pliers  
for bending wires up to  $\varnothing$  0.9mm,  
disinfectable, sterilizable  
4 3/4" (12cm)



202-0051  
Bending plier for lingual cleat  
5 1/2" (14cm)



**202-0052**  
Bracket Removing Pliers  
5 1/2" (14 cm)



**202-0053**  
Bracket Removing Pliers  
5 1/2" (14 cm)



**202-0054**  
Bracket Removing Pliers  
5 1/2" (14 cm)



**202-0055**  
Bracket Removing Pliers  
5 1/2" (14cm)

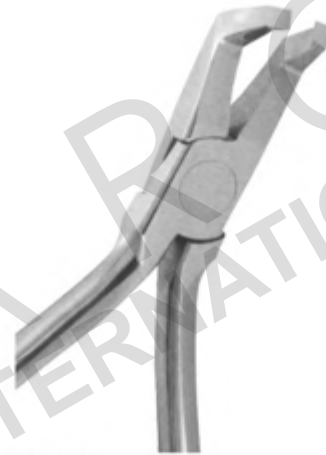

**202-0056**  
Bracket Removing Pliers  
5 1/2" (14cm)



**202-0057**  
Flat Pliers  
5 1/2" (14 cm)



**202-0058**  
Nance Closing Loop Pliers  
5 1/2" (14 cm)



**202-0059**  
Angle Bending Pliers  
5 1/2" (14 cm)



**202-0060**  
Crown Crimping Pliers  
5 1/2" (14 cm)

## ●●● PLIERS FOR ORTHODONTICS & PROSTHETICS



202-0061  
Round & Flat Plier  
5 1/2" (14 cm)



202-0062  
Tweed Angle Arch Bending  
5 1/2" (14 cm)



202-0063  
Band Removing Pliers  
5 1/2" (14 cm)



202-0064  
Johnson Contouring Pliers  
5 1/2" (14 cm)

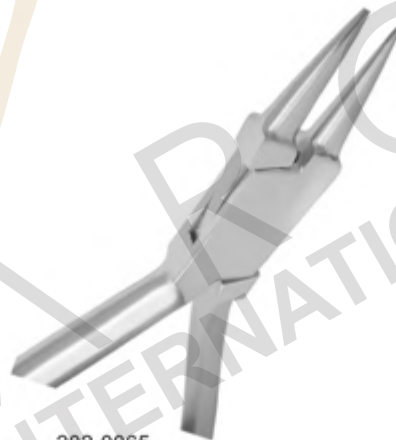

202-0065  
Round Nose Pliers  
5 1/2" (14 cm)



202-0066  
Tweed Angle Arch Bending  
5 1/2" (14 cm)



202-0067  
De La Rosa Pliers  
5 1/2" (14 cm)



202-0068  
Arch Forming Plier  
5 1/2" (14 cm)



202-0069  
Tweed Angle Arch Bending  
5 1/2" (14 cm)





202-0070  
Flat Nose Plier  
5 1/2" (14 cm)



202-0071  
How Pliers  
5 1/2" (14 cm)



202-0072  
Gordon - Contouring  
5 1/2" (14 cm)



202-0073  
Adams Pliers  
5 1/2" (14 cm)



202-0074  
Adams Pliers  
5 1/2" (14 cm)

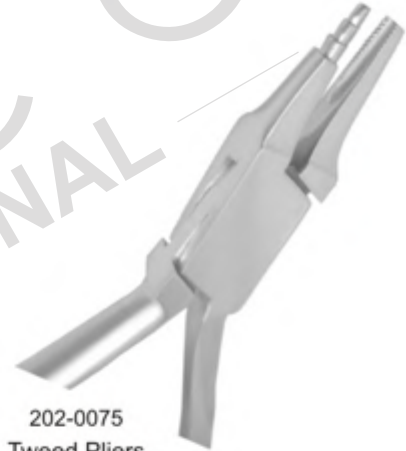

202-0075  
Tweed Pliers  
5 1/2" (14 cm)

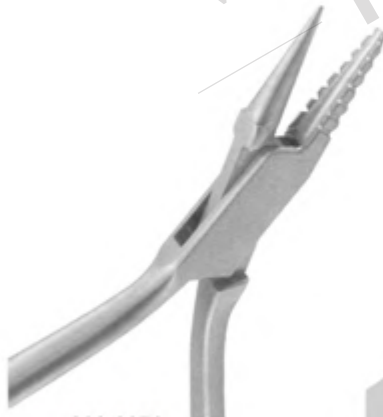

202-0076  
Bending Pliers  
mediumfine, with graduation,  
for wires up to 1.0mm  
5 1/2" (14cm)



202-0077  
Special pliers  
max .022" x .028"  
5 1/2" (14cm)



202-0078  
Pliers for operating the Mobil-Stop  
5 1/2" (14cm)

## ●●● PLIERS FOR ORTHODONTICS & PROSTHETICS



202-0079  
Light wire pliers for wires  
up to  $\varnothing$  0.60mm  
with cutter Begg  
4  $\frac{3}{4}$ " (12cm)



202-0080  
Weingart Universal Pliers  
5  $\frac{1}{2}$ " (14 cm)



202-0081  
Weingart ultra lightwire Pliers  
5  $\frac{1}{2}$ " (14 cm)



202-0082  
Weingart Universal lightwire Pliers  
max .022" x .028  
5  $\frac{1}{2}$ " (14cm)



202-0083  
Universal Facebow Pliers  
6  $\frac{1}{2}$ " (16.5cm)



202-0084  
Distel Cutter Light Weight  
5 1/2" (14 cm)



202-0085  
Distel Cutter medium  
5 1/2" (14 cm)



202-0086  
Ligature Pin Cutter  
5 1/2" (14 cm)



201-0087  
Hard Wire Cutter  
5 1/2" (14 cm)



202-0088  
Hard Wire Cutter  
5 1/2" (14 cm)



202-0089  
Bracket Removing Pliers  
5 1/2" (14 cm)



202-0090  
Arch torquing and bending pliers  
for wires up to ø 0.60mm  
allow to user a pair  
4 3/4" (12cm)



## ●●● BONE RONGEURS



203-0001  
BEYER  
150mm (6")  
5mm bite



203-0002  
JANSEN-MIDDLETON  
SEPTUM FORCEPS  
200mm (8") Spoon shaped  
4mm bite

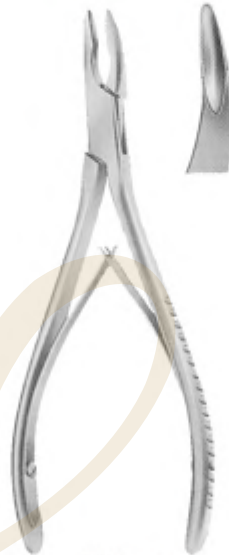

203-0003  
CAIRNS  
140mm (5.1/2")  
4mm bite



203-0004  
CAIRNS  
140mm (5.1/2")  
4mm bite



203-0005  
LUER  
155mm (6")



203-0006  
RUSKIN  
190mm (7.1/2")  
6mm bite



203-0007  
HARTMANN  
180mm (7")



203-0008  
MEAD  
165mm (6.1/2")



203-0009  
JANSEN  
150mm (6")



203-0010  
TROTTER  
200mm (8")  
10mm bite



203-0011  
SYNOVECTOMY  
RONGEUR  
175mm (7")



203-0012  
HEANLEY  
175mm (7")  
4mm bite



203-0013  
PENNYBACKER  
200mm (8")  
4mm bite



203-0014  
SYNOVECTOMY  
RONGEUR  
130mm (5.1/8")  
Jaw width 2mm



203-0015  
NORTHFIELD  
200mm (8")  
10mm bite



203-0016  
WILMS  
200mm (8")  
4mm bite



LEKSELL  
203-0017  
240mm  
(9.1/2")  
6mm bite

203-0018  
240mm  
(9.1/2")  
8mm bite

## ●●● BONE RONGEURS



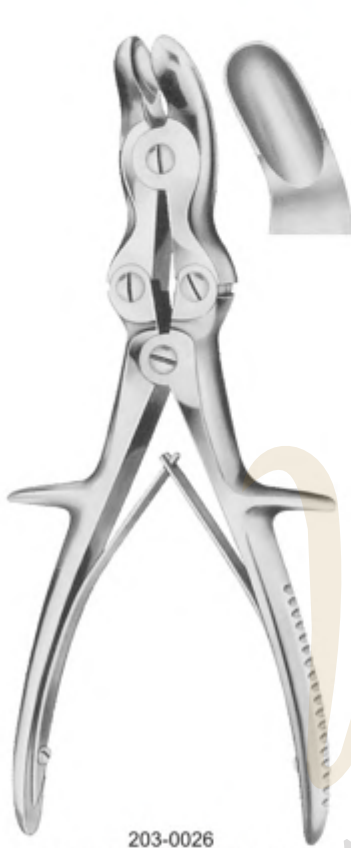

203-0026  
SARGENT (VAN HAVRE)  
220mm (8.3/4")  
10mm bite



203-0027  
OLIVECRONA  
230mm (9")  
6mm bite



203-0028  
STILLE-RUSKIN  
240mm (9.1/2")

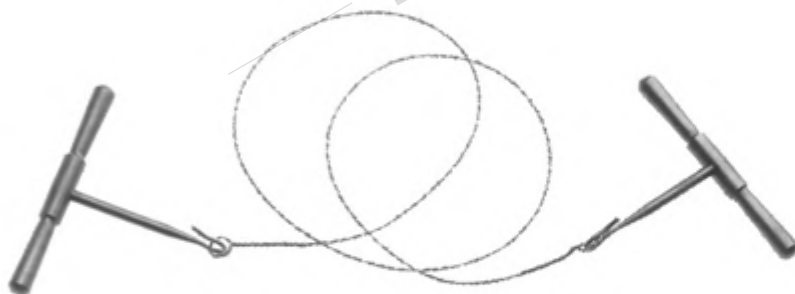

203-0029  
GIGLI SAW WITH HANDLE  
500mm (20")



203-0030  
RUDOR EDWARDS COSTOTOME  
230mm (9")

## ●●● ROOT ELEVATORS

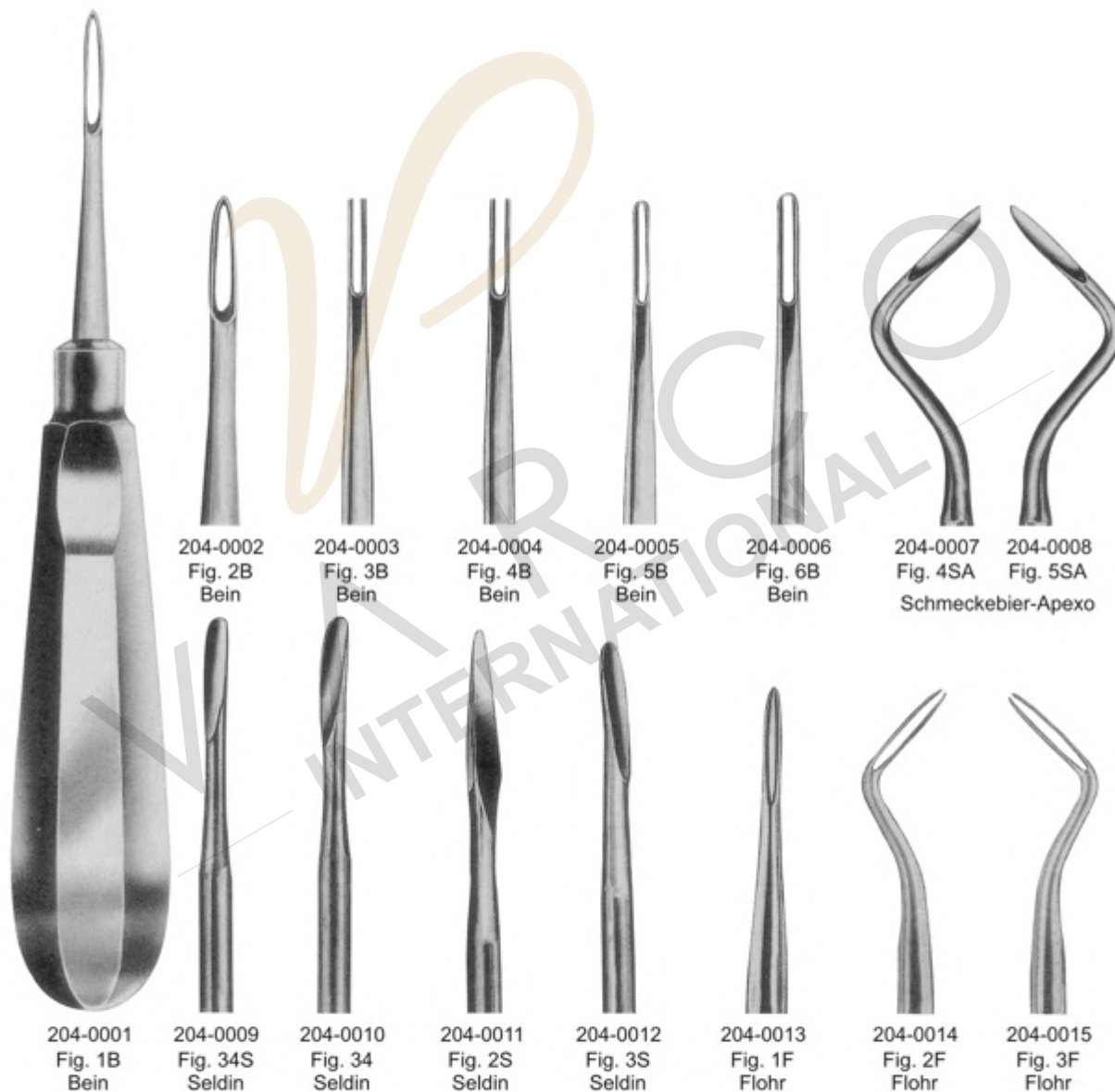





## ●●● ROOT ELEVATORS



204-0031  
Fig. A  
Cogswell



204-0032  
Fig. B  
Cogswell



204-0033  
Fig. 301  
Apexo



204-0034  
Fig. 302  
Apexo



204-0035  
Fig. 303  
Apexo



204-0036  
Fig. 301W  
Seldin



204-0037  
Fig. 304W  
Seldin



204-0038  
Fig. 1H  
Heidbrink



204-0039  
Fig. 2H  
Heidbrink



204-0040  
Fig. 40H  
Heidbrink



204-0041  
Fig. 41H  
Heidbrink



204-0042  
Fig. 46



204-0043  
Fig. 46R



## ●●● ROOT ELEVATORS





204-0075  
Fig. 1  
Bein



204-0076  
Fig. 2  
Bein



204-0077  
Fig. 3  
Bein



204-0078  
Fig. 4  
Bein



204-0079  
Fig. 5  
Bein



204-0080  
Fig. 6  
Bein



204-0081  
Fig. 1



204-0082  
Fig. 2



204-0083  
Fig. 2  
Flohr



204-0084  
Fig. 3  
Flohr



204-0085  
Fig. 3  
Cryer



204-0086  
Fig. 8  
Cryer

## ●●● ROOT ELEVATORS

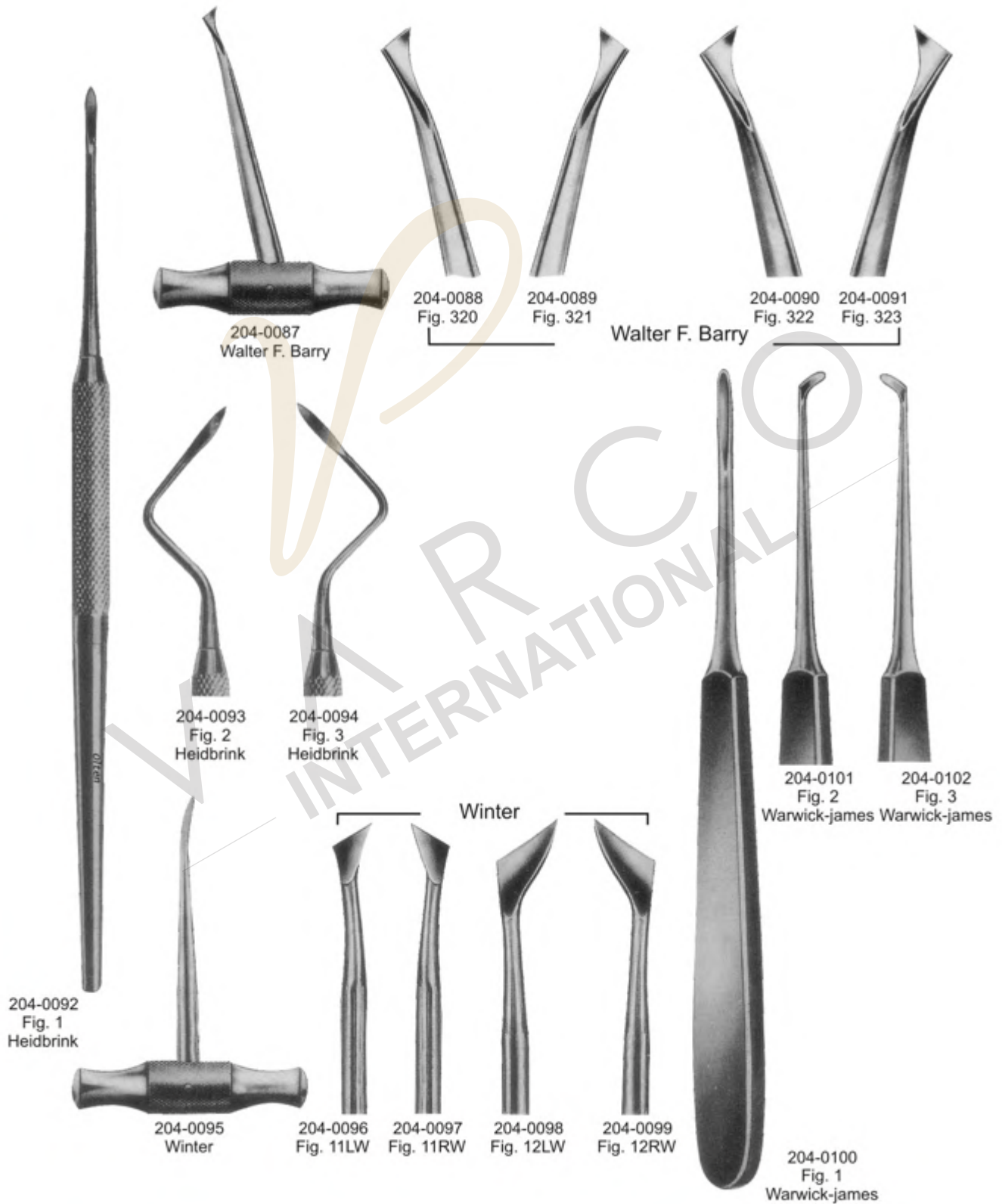

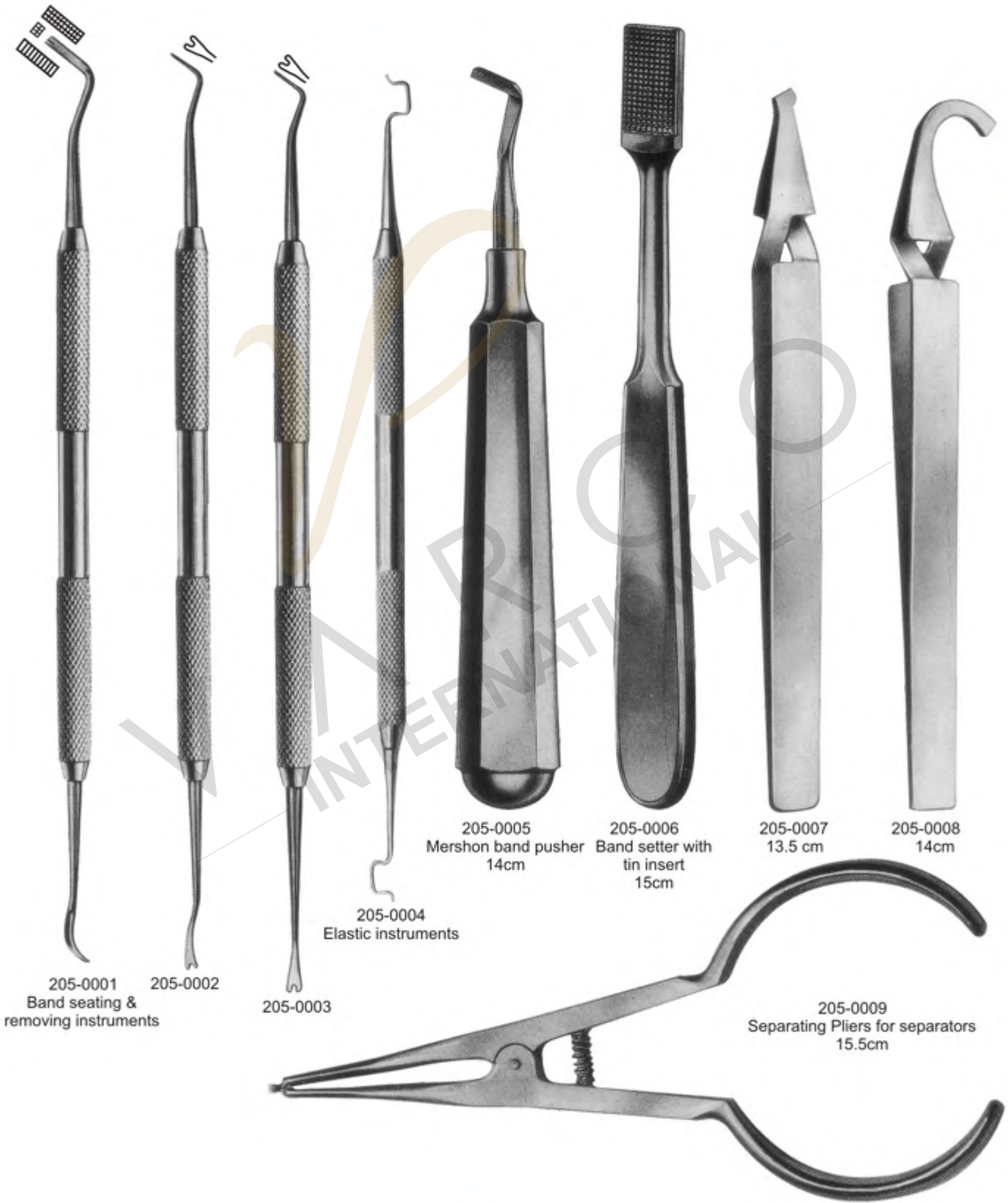

205-0001 205-0002  
Band seating & removing instruments

205-0003  
205-0004  
Elastic instruments

205-0005  
Mershon band pusher  
14cm

205-0006  
Band setter with tin insert  
15cm

205-0007  
13.5 cm

205-0008  
14cm

205-0009  
Separating Pliers for separators  
15.5cm

## ●●● ORTHODONTICS INSTRUMENTS



205-0010  
Mathieu pliers  
14cm



205-0011  
Elastic ligature placing pliers  
14cm



205-0012  
Mathieu ligating pliers  
14cm



205-0013  
Mathieu pliers  
with finger ring  
14cm



205-0014  
Straight 5"  
Mosquito Forceps  
205-0015  
Curved 5"



205-0016  
Ligature tying piler



205-0017  
Bracket positioning gauge

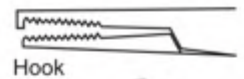

Hook



205-0023  
Straight 5"  
Mosquito Forceps  
205-0024  
Curved 5"



205-0018  
Bracket placing  
tweezer



205-0019  
Bracket placing  
tweezer



205-0020  
Clamping Tweezer



205-0021  
Bracket holding  
tweezer



205-0022  
Band seating  
instruments  
nylon





206-0001  
Fig. 1  
12cm Straight



206-0002  
Fig. 2  
12cm curved

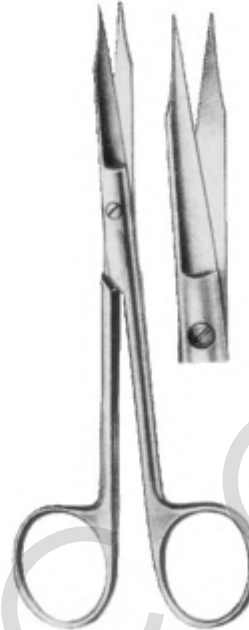

206-0003  
Fig. 1  
13cm  
Goldman-Fox  
Saw edge  
Straight



206-0004  
Fig. 2  
13cm  
Goldman-Fox  
Saw edge  
curved

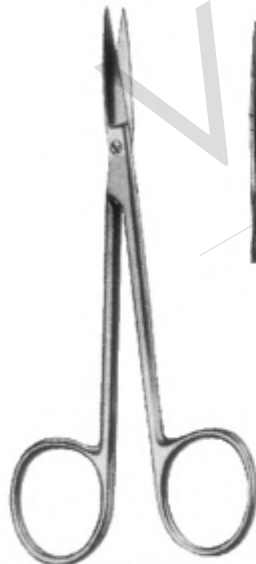

206-0005  
Fig. 1  
11.5cm  
Iris Straight

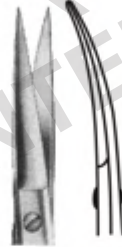

206-0006  
Fig. 2  
11.5cm  
Iris  
Curved



206-0007  
Fig. 3  
11.5cm  
Iris



206-0008  
Fig. 1  
11.5cm  
Angular Saw edge



206-0009  
Fig. 2  
11.5cm  
Angular

## ●●● GUM SCISSORS



206-0010  
Fig. 1  
La Grange  
11.5cm

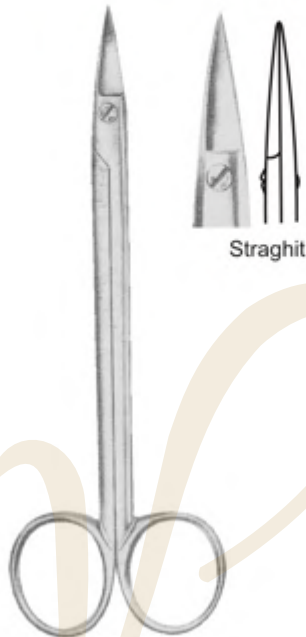

206-0011  
Fig. 1  
Quinby  
12.5cm

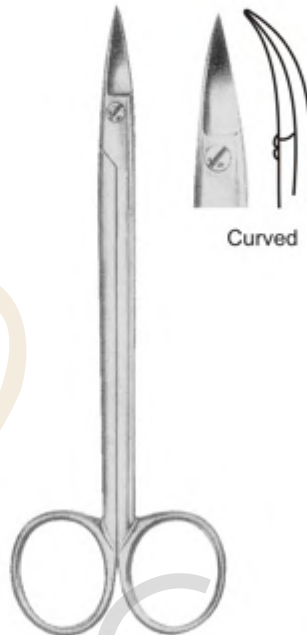

206-0012  
Fig. 2  
Quinby  
12.5cm



206-0013  
Fig. 3  
Goldman-Fox (Special)  
saw edge  
12.5cm

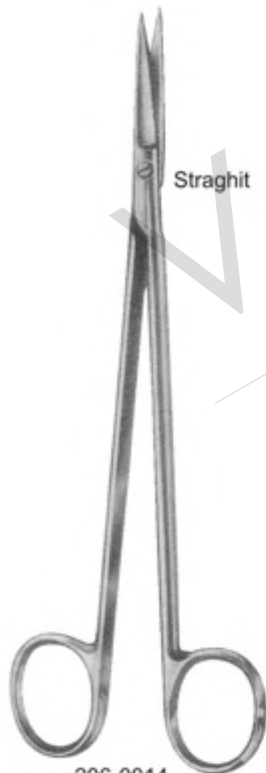

206-0014  
Fig. 1  
Kelly  
16cm

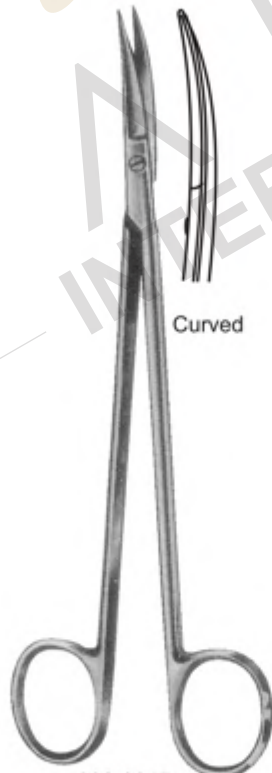

206-0015  
Fig. 2  
Kelly  
16cm



206-0016  
Fig. 1  
Locklin  
16.5 cm



206-0017  
Fig. 2  
Locklin  
16.5cm



## ●●● SURGICAL SCISSORS



206-0026  
Fig. 1  
Mayo  
14.5cm

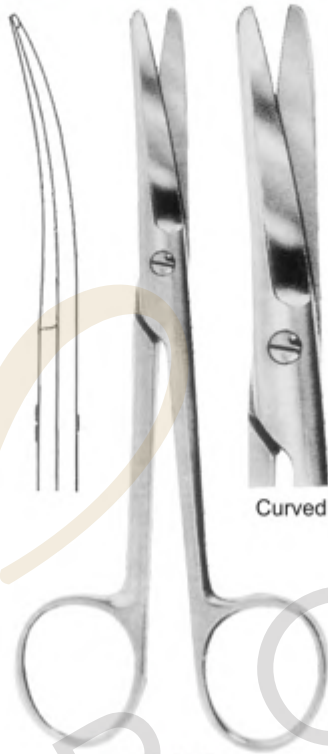

206-0027  
Fig. 2  
Mayo  
14.5cm



206-0028  
Fig. 2  
Metzenbaum  
14.5cm

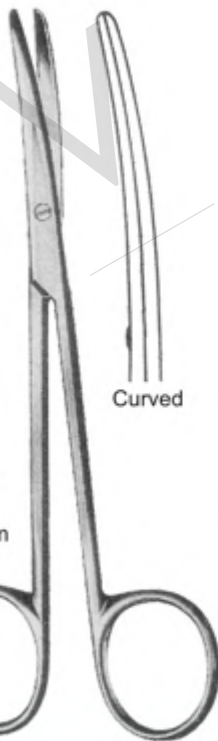

206-0029  
Fig. 2  
Metzenbaum  
14.5cm



206-0030  
Fig. 2  
Metzenbaum-delicate  
14.5cm

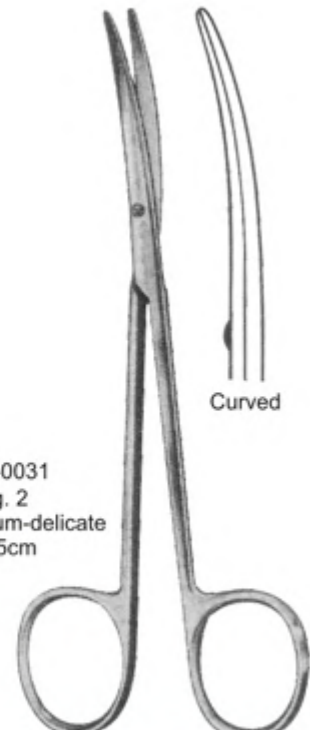

206-0031  
Fig. 2  
Metzenbaum-delicate  
14.5cm



## ●●● HAEMOSTATIC FORCEPS

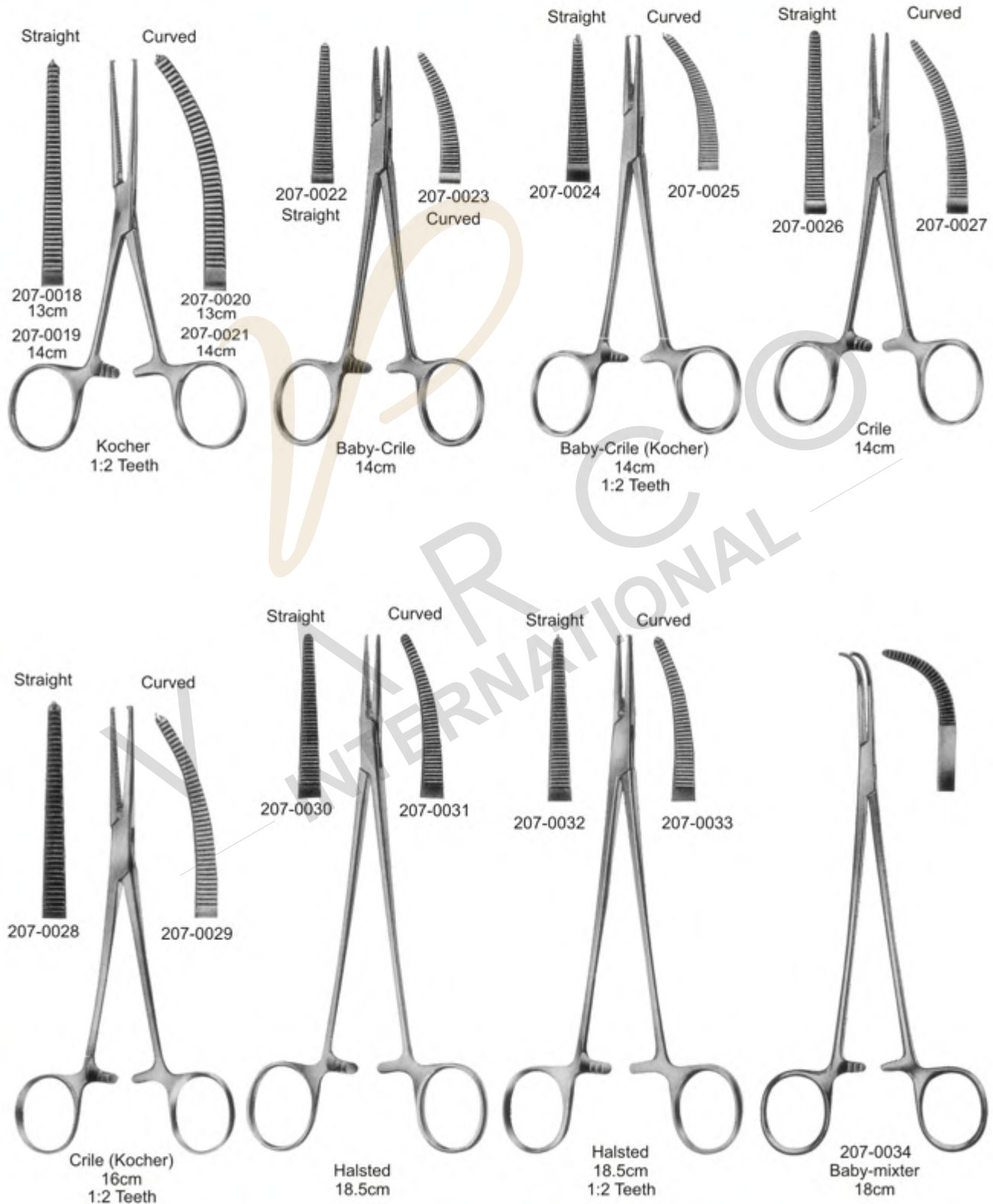



207-0035  
Without Ratchet  
14.5cm



207-0036  
With Ratchet  
14.5cm



207-0037  
Curved  
17.5cm



207-0038  
Curved  
21cm

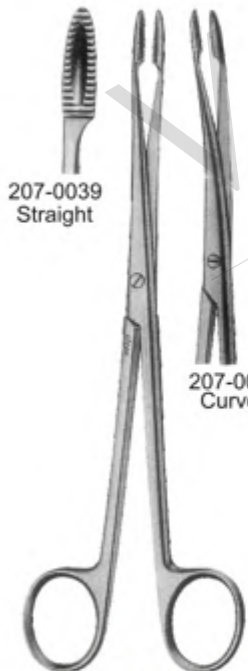

207-0039  
Straight

Without Ratchet  
18cm

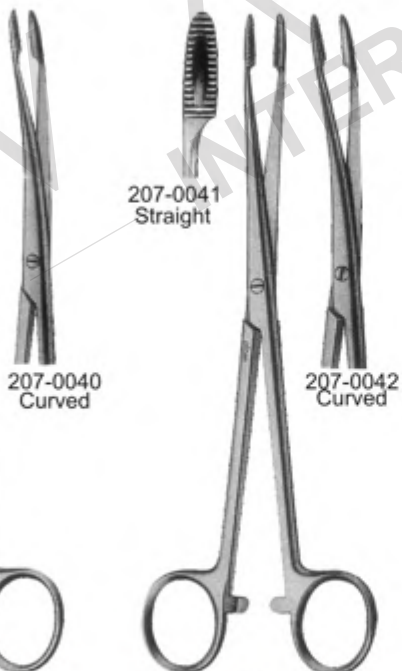

207-0040  
Curved

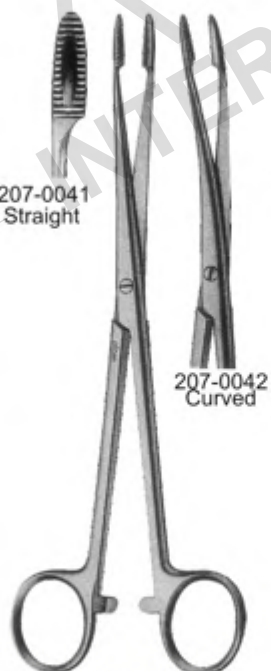

207-0041  
Straight

With Ratchet  
18cm



207-0042  
Curved

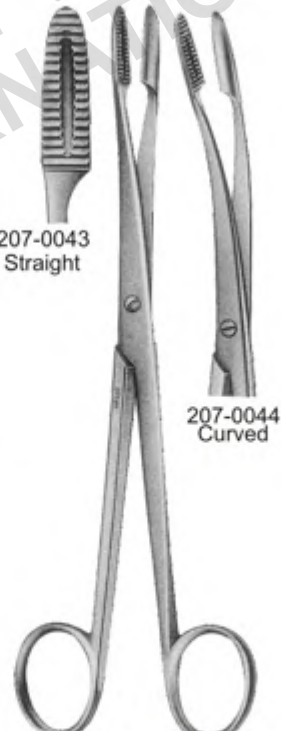

207-0043  
Straight

Without Ratchet  
20cm



207-0044  
Curved

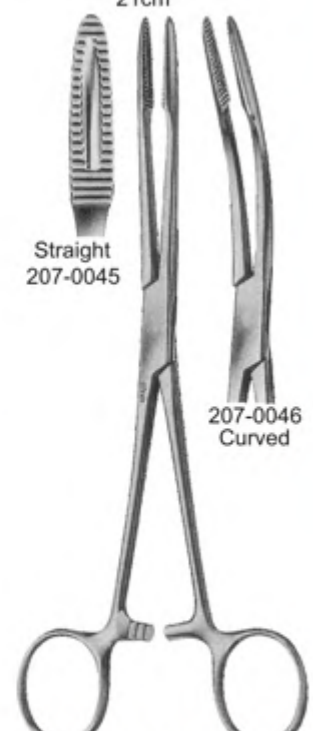

Straight  
207-0045

With Ratchet  
20cm



207-0046  
Curved

●●● TOWEL CLAMPS Sterilizing Forceps For Sterile Instruments

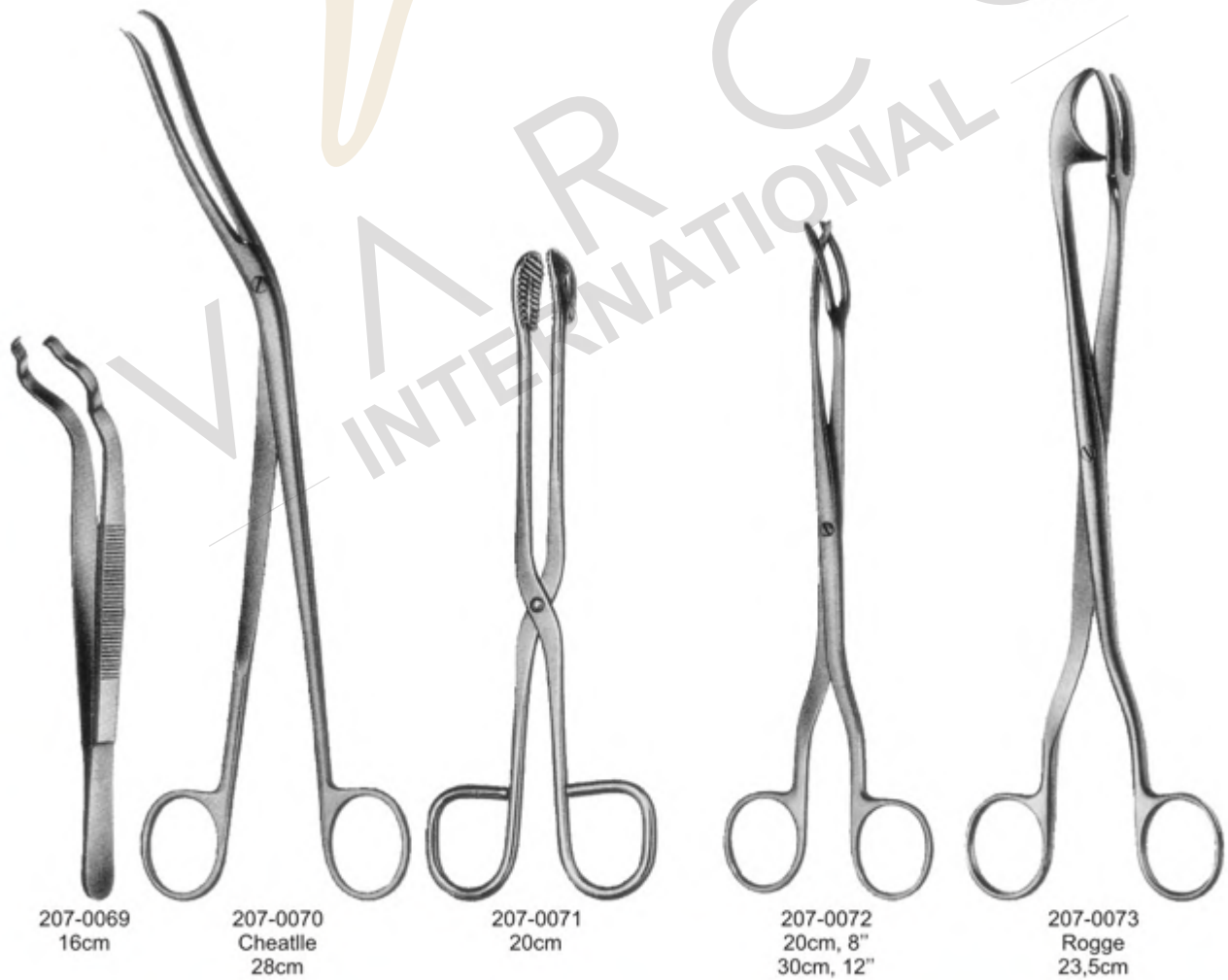
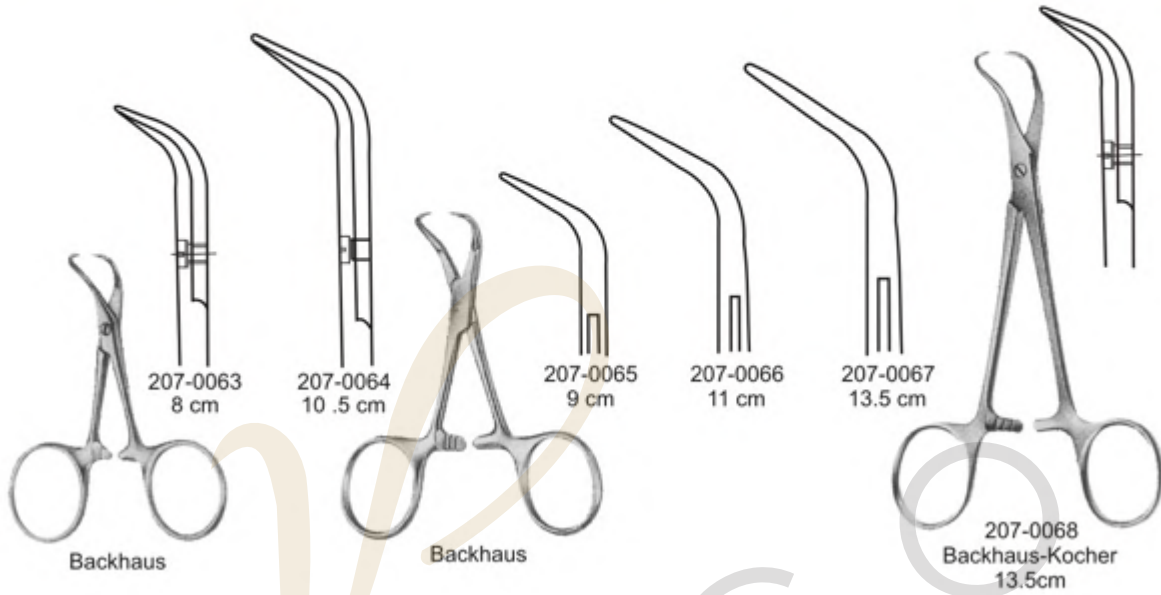



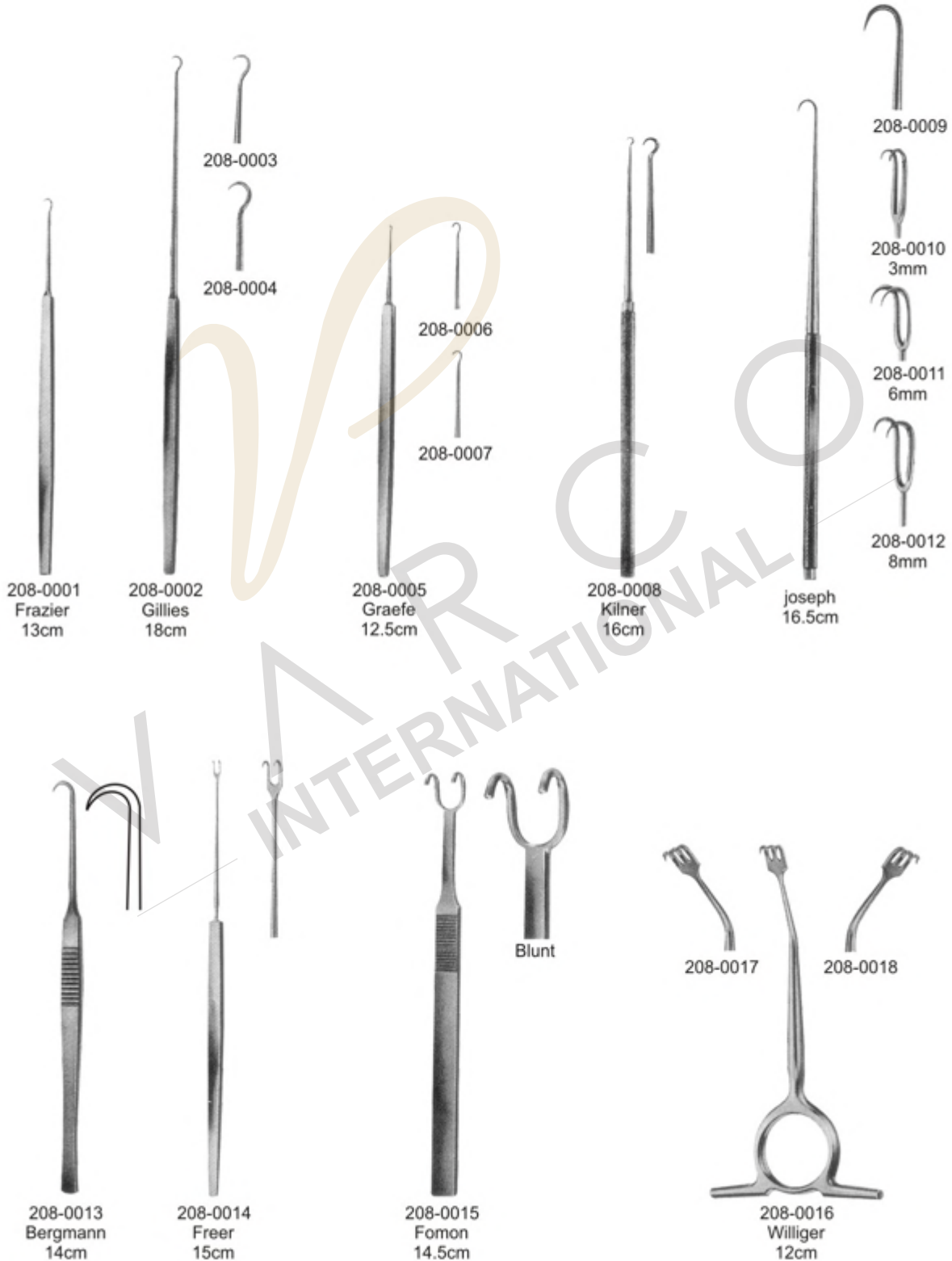

## ●●● RETRACTORS

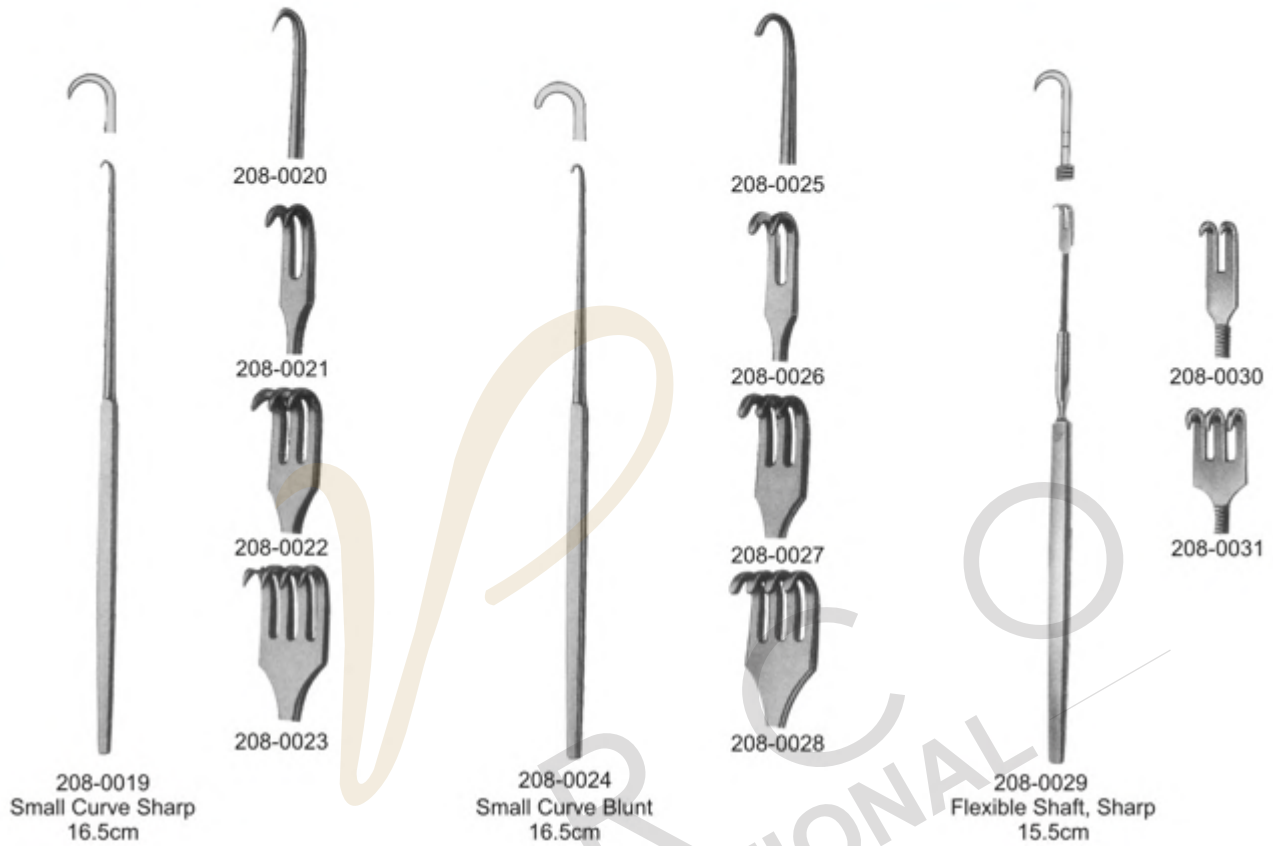

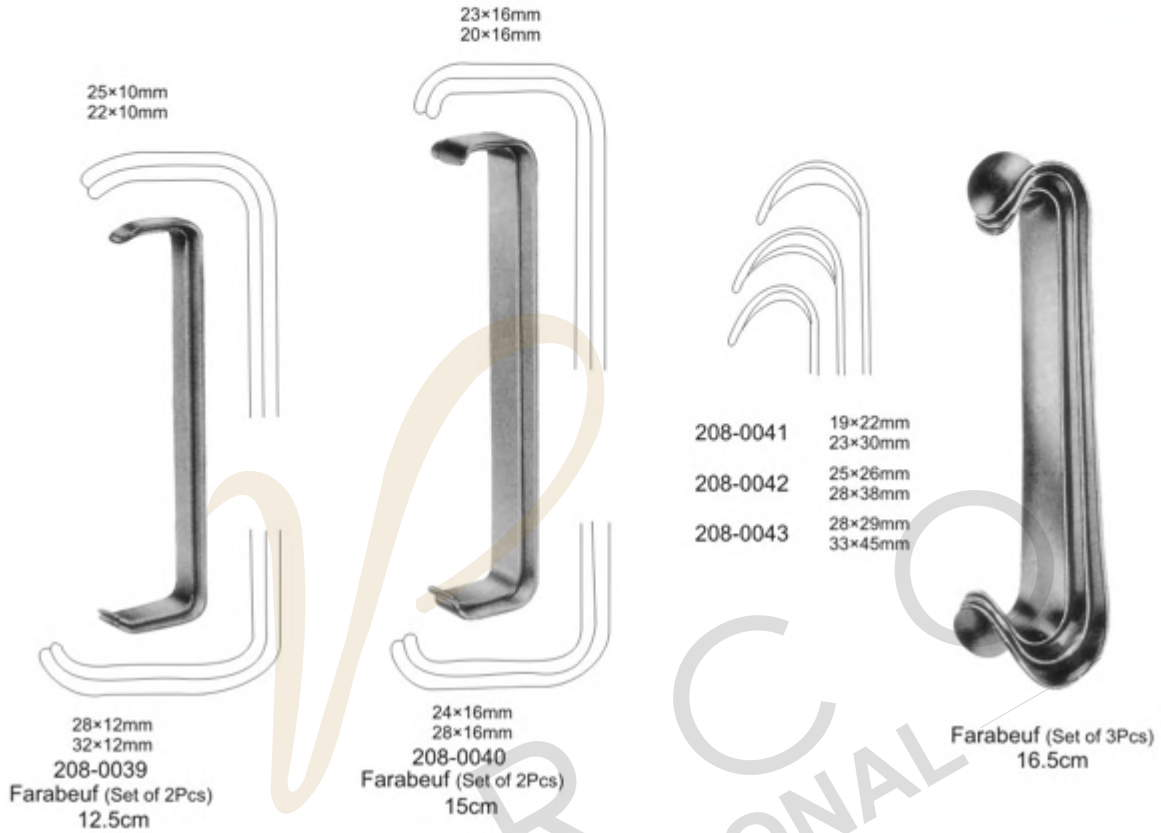

## ●●● CHEEK RETRACTORS



Middeldorpf



208-0053  
15×15mm  
22cm



208-0054  
20×22mm  
21.5cm



208-0055  
28×28mm  
23.5cm



208-0056  
Greene  
22.5cm



208-0057  
Buchs  
20.5cm



208-0058  
28×10mm



208-0059  
28×14mm



208-0060  
33×14mm



208-0061  
28×16mm

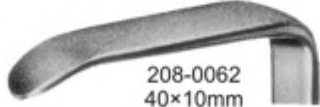

208-0062  
40×10mm

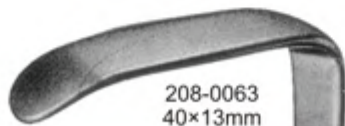

208-0063  
40×13mm



Langenbeck  
21cm



208-0064  
Kocher  
21cm



23×8mm



208-0066  
Blunt

208-0065  
Alm (Sharp)  
7cm



208-0067  
Alm (Sharp)  
10cm

208-0068  
Blunt



## ●●● ELEVATORS

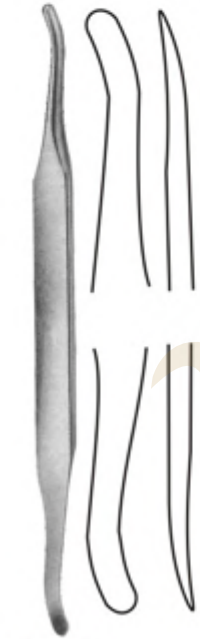

208-0077  
Scladin  
19.5cm



208-0078  
Scladin  
19.5cm



208-0079  
Chompret  
15cm



208-0080



208-0081

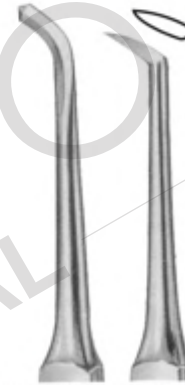

208-0082

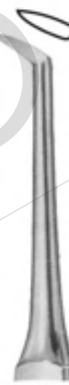

208-0083

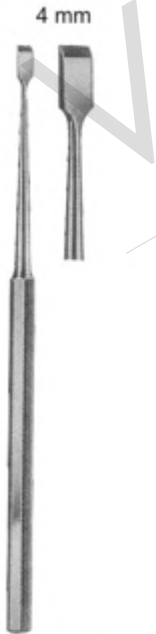

208-0084  
Freer  
16cm



208-0085  
Freer  
16cm

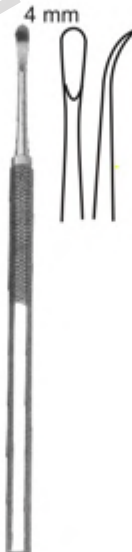

208-0086  
Partsch, mod  
14.5cm



208-0087  
Mead  
16.5cm



208-0088  
Mead  
18cm



## ●●● CHISELS & GOUGES





Calmp forceps



209-0001  
Ivory light weight  
17cm

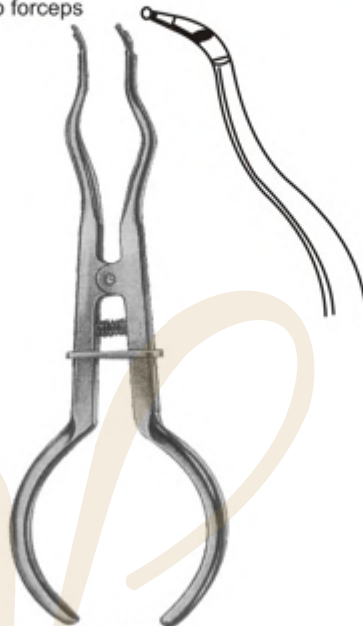

209-0002  
Brewer  
17.5cm

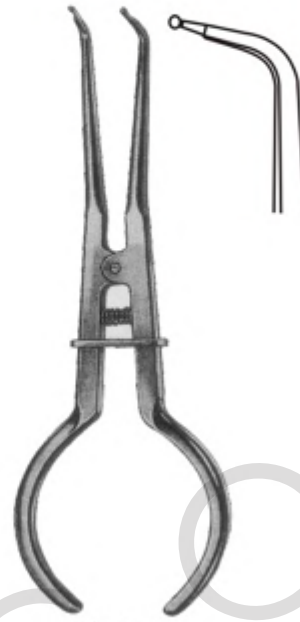

209-0003  
Stokes  
17.5cm

Punch forceps



209-0004  
Ainsworth  
17cm



209-0005  
Ivory  
17cm

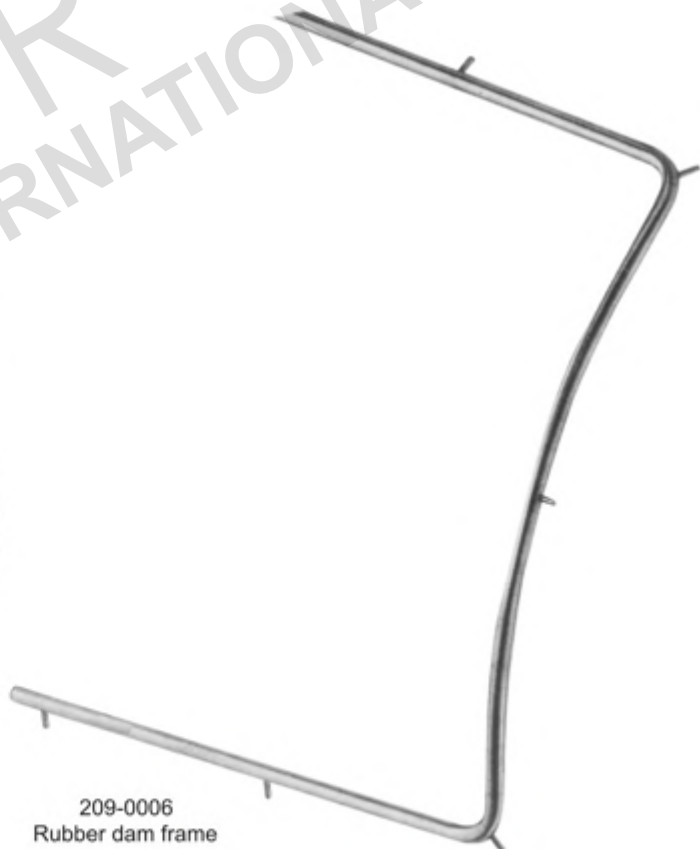

209-0006  
Rubber dam frame

## ●●● TISSUE PLIERS

210-0001  
Adson, 12cm



210-0002  
Adson1x2, 12cm

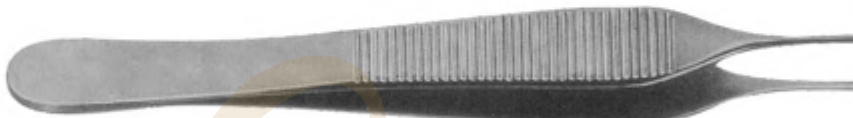

210-0003  
Fig. 1  
Semken-Taylor  
12.5 cm



210-0004  
Fig. 2  
Semken-Taylor  
12.5cm

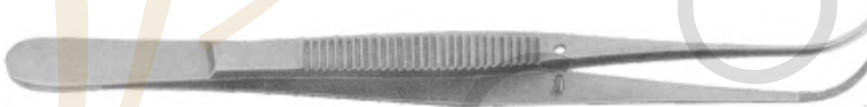

210-0005  
Fig. 1  
Semken-Taylor 1x2  
12.5cm



210-0006  
Fig. 2  
Semken-Taylor 1x2  
12.5cm

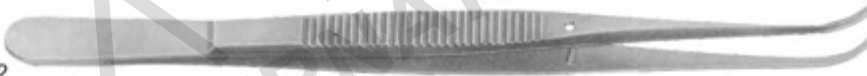

210-0007  
12cm



210-0008  
11.5cm



210-0009  
11.5cm



210-0010  
11.5cm



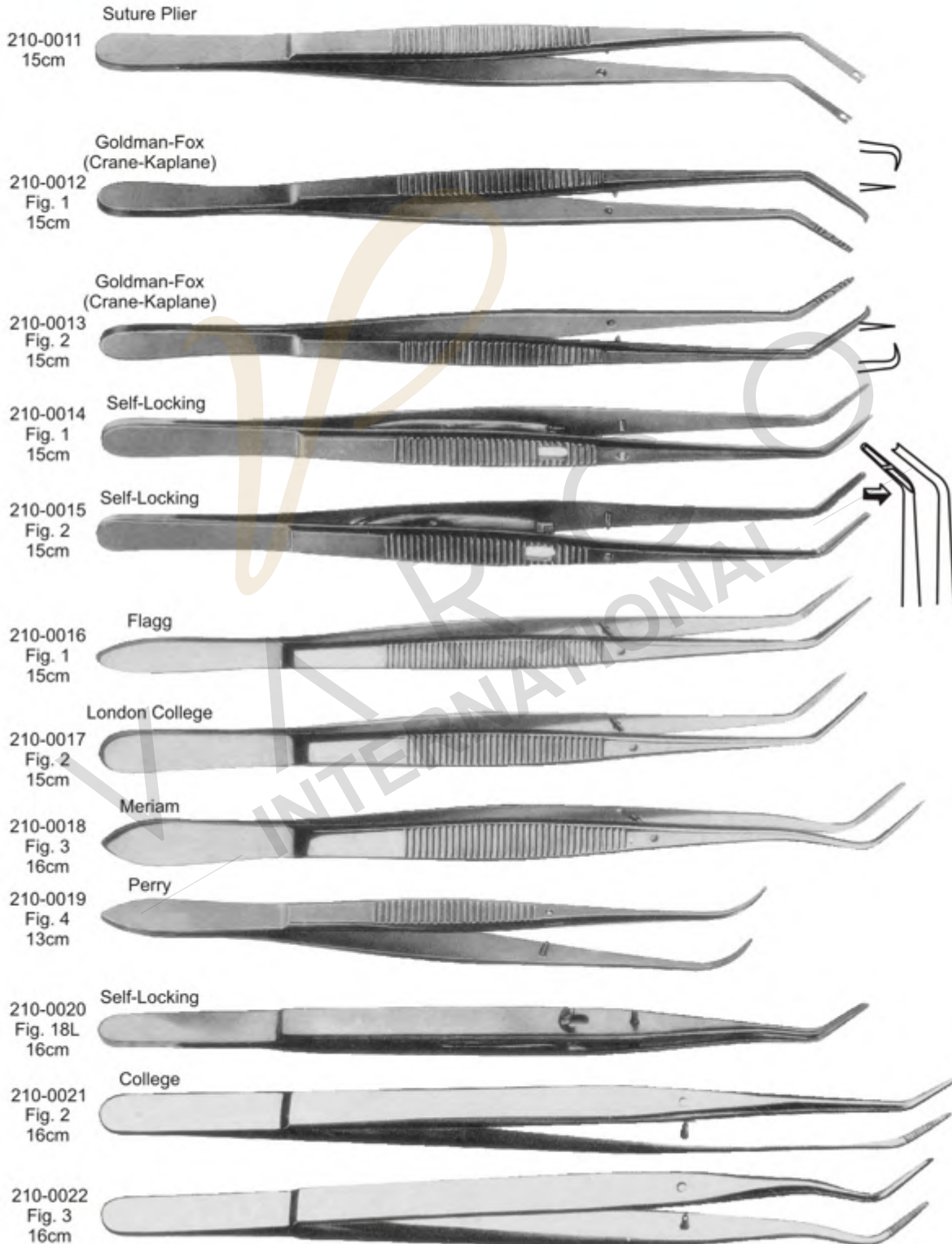

## ●●● SCALPEL HANDLES



211-0001  
No.3L



211-0002  
ERGONOMIC



211-0003  
No.7



211-0004



211-0005



211-0006



211-0007  
No.4L



211-0008  
No.4



211-0009  
No.10



211-0010  
No.9



211-0011  
No. 3



211-0012  
BARRON  
For "B.P." type blades  
for use with No's  
10,11,12 & 15 blades  
135mm (5.1/4")

## ●●● HANDLES REFERENCE GUIDE



211-0013  
Single ended  
Knurling round



211-0014  
Double ended  
Knurling round

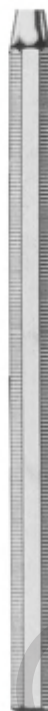

211-0015  
Single ended  
octangle serrated



211-0016  
Double ended  
octangle serrated



211-0017  
Single ended  
hollow round



211-0018  
Double ended  
hollow round



211-0019  
Double ended  
hollow round grooved



211-0020  
Double ended  
swiss pattern octangle



212-0001  
CASTROVIEJO  
145mm (5.3/4")  
With catch



212-0002  
CASTROVIEJO  
145mm (5.3/4")  
With catch



212-0003  
ARRUGA  
135mm (5.1/4")



212-0004  
BARRAQUER  
120mm (4.3/4")  
With catch



212-0005  
BARRAQUER  
120mm (4.3/4")  
Without catch



212-0006  
CONVERSE  
125mm (5")



212-0007  
DERF  
120mm (4.3/4")



212-0008  
MAYO (DUNHILL)  
160mm (6.1/4")



212-0009  
MAYO  
180mm (7")

## ●●● NEEDLE HOLDERS



212-0010  
MAYO  
190mm (7.1/2")

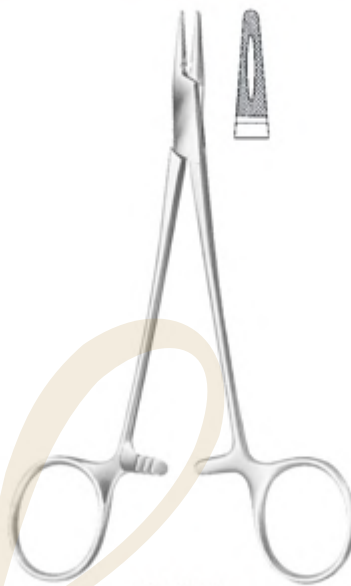

212-0011  
CRILE WOOD  
150mm (6")



212-0012  
CRILE MURRAY  
145mm (5.3/4")



212-0013  
KILNER  
135mm (5.1/4")



NAUNTUN MORGAN

212-0014  
190mm (7.1/2")  
212-0015  
250mm (10")



WANGENSTEEN

212-0016  
270mm (10.3/4")



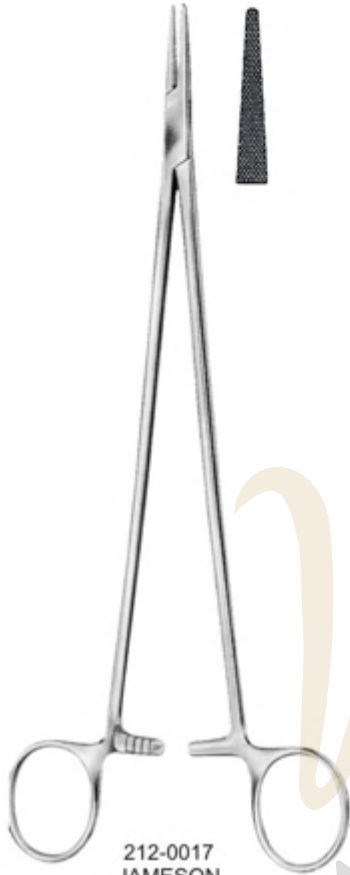

212-0017  
JAMESON  
230mm (9")



212-0018  
WRIGHT  
125mm (5")



212-0019  
GILLIES  
Combined needle holder  
and scissors  
160mm (6.1/4")

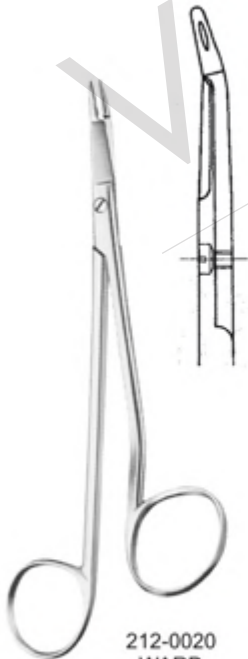

212-0020  
WARD  
Combined needle holder  
and scissors  
180mm (7")



212-0021  
HEANEY  
200mm (8")

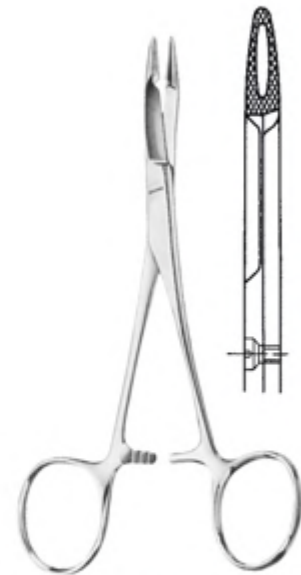

OLSEN HEGAR  
Combined needle holder  
and scissors  
212-0022 140mm (5.1/2")  
212-0023 165mm (6.1/2")  
212-0024 190mm (7.1/2")

## ●●● NEEDLE HOLDERS



212-0025  
MAYO (BAUMGARTNER)  
140mm (5.1/2")



212-0026  
MAYO (MASSON)  
265mm (10.1/2")



212-0027  
MAYO  
65mm (6.1/2")



212-0028  
190mm (7.1/2")



212-0029  
200mm (8")



212-0030  
230mm (9")



212-0031  
HEGAR  
200mm (8")



212-0032  
HALSEY  
125mm (5")



212-0033  
MATHIEU  
140mm (5.1/2")



212-0034  
MATHIEU  
170mm (6.3/4")



212-0035  
MATHIEU  
200mm (8")

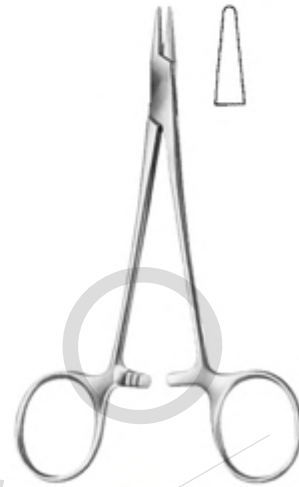

212-0036  
WEBSTER  
Smooth Jaw  
115mm (4.1/2")



212-0037  
MAYO  
150mm (6")



212-0038  
MCPHAILS  
180mm (7")



LAWRANCE  
212-0039 150mm (6")  
Lightweight  
212-0040 150mm (6")

## ●●● MOUTH MIRRORS



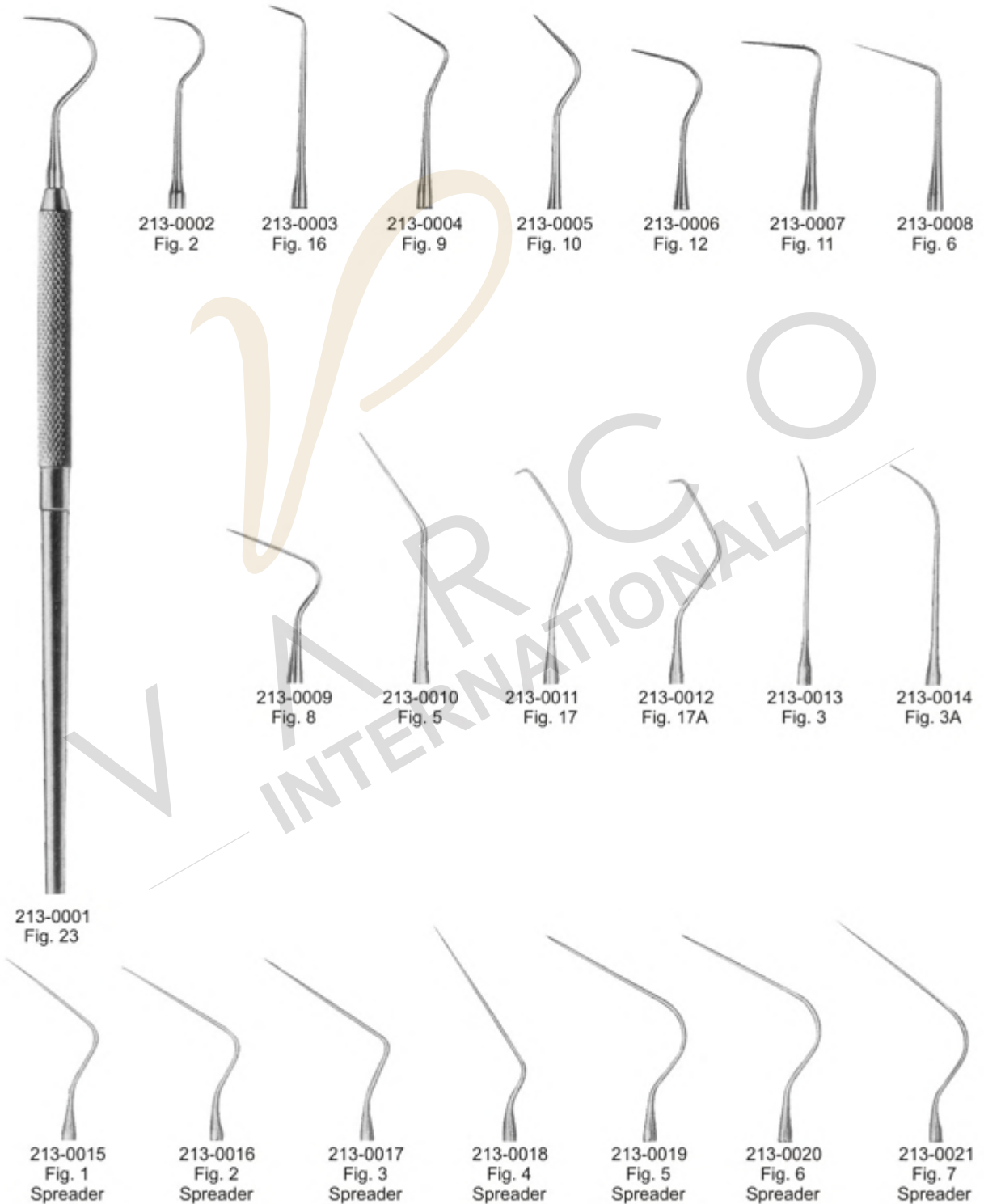

●●● EXPLORERS PROBES

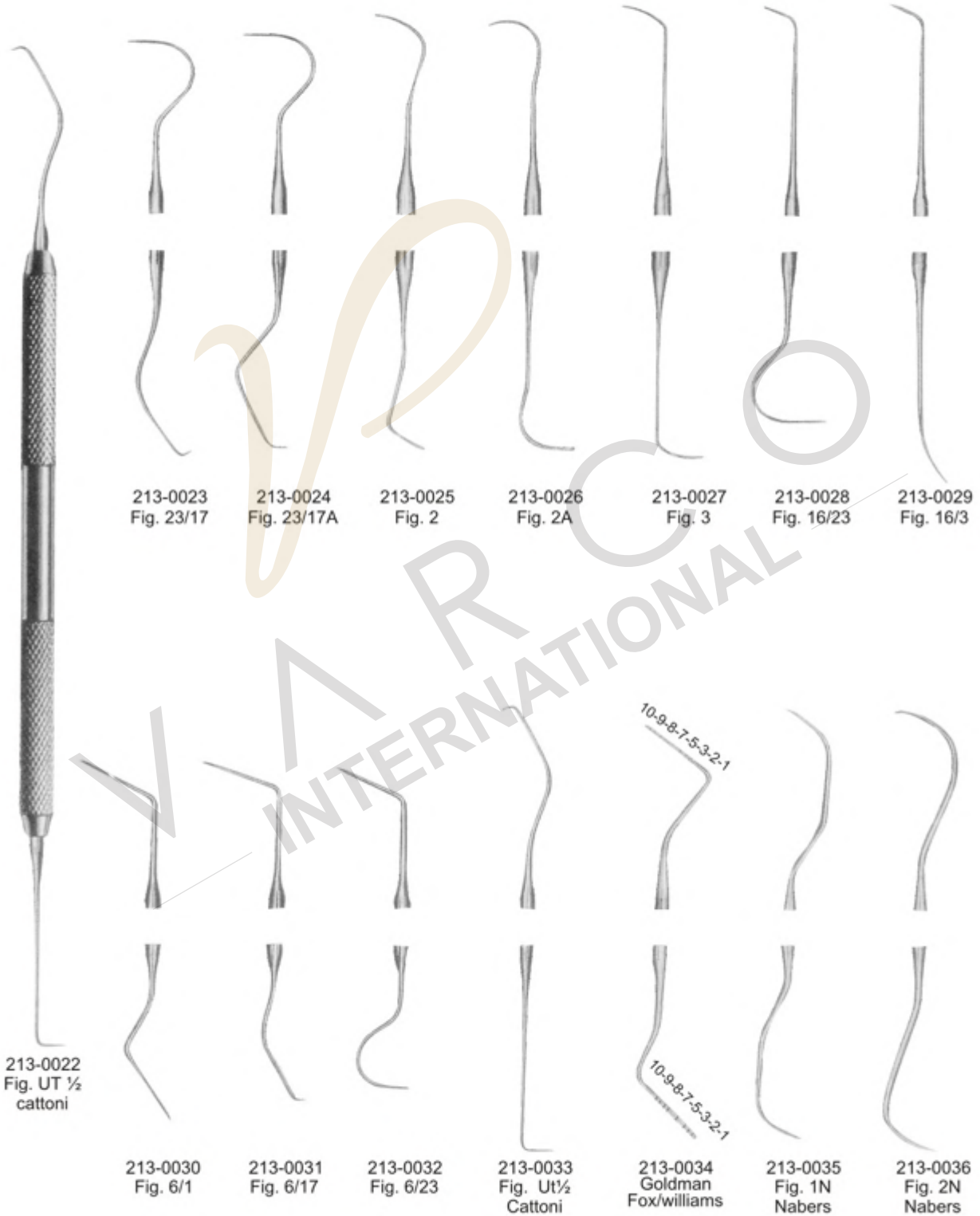

Root canal explorers

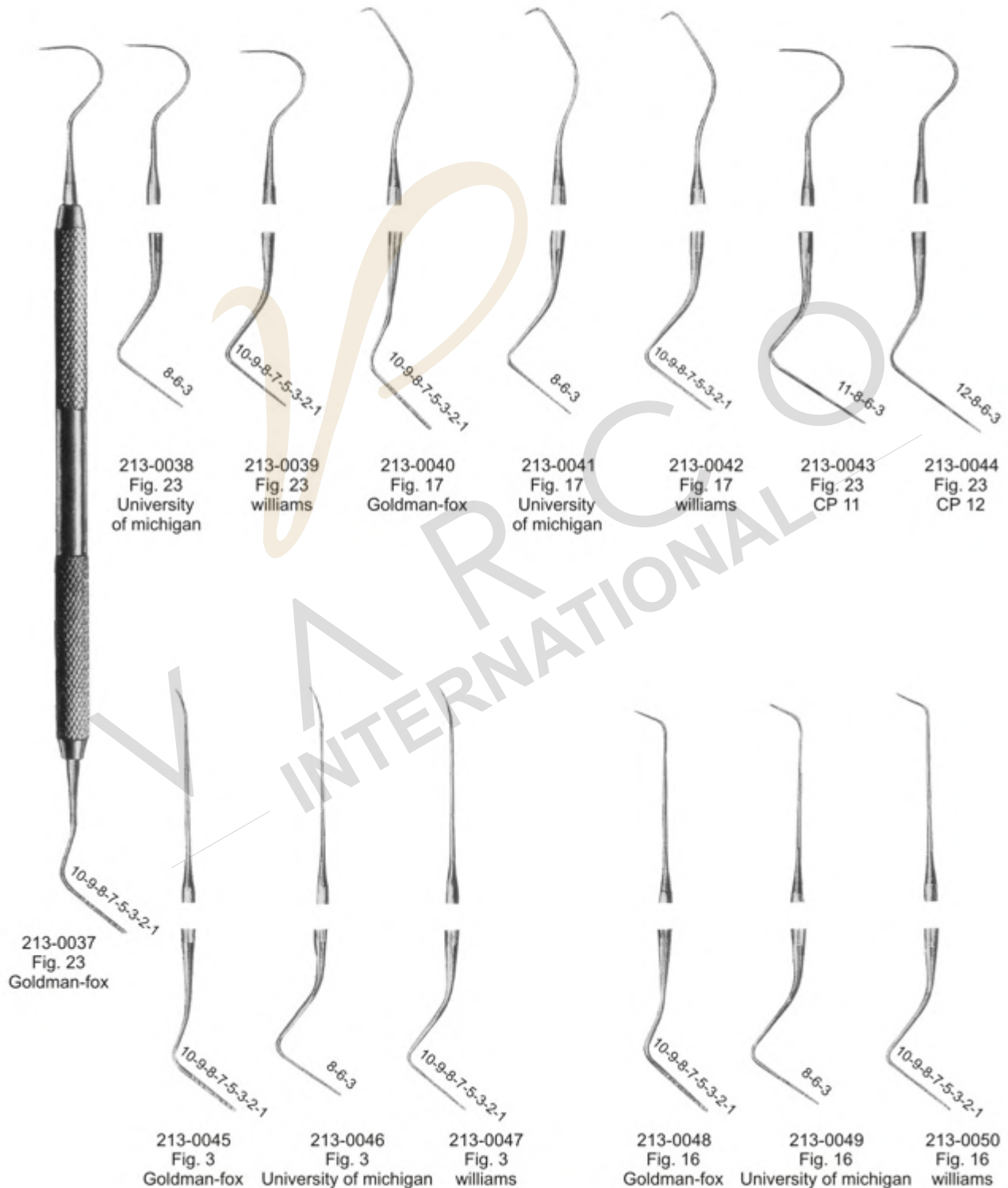

## ●●● PERIODONTAL POCKET PROBES ENDODONTIC INSTRUMENTS

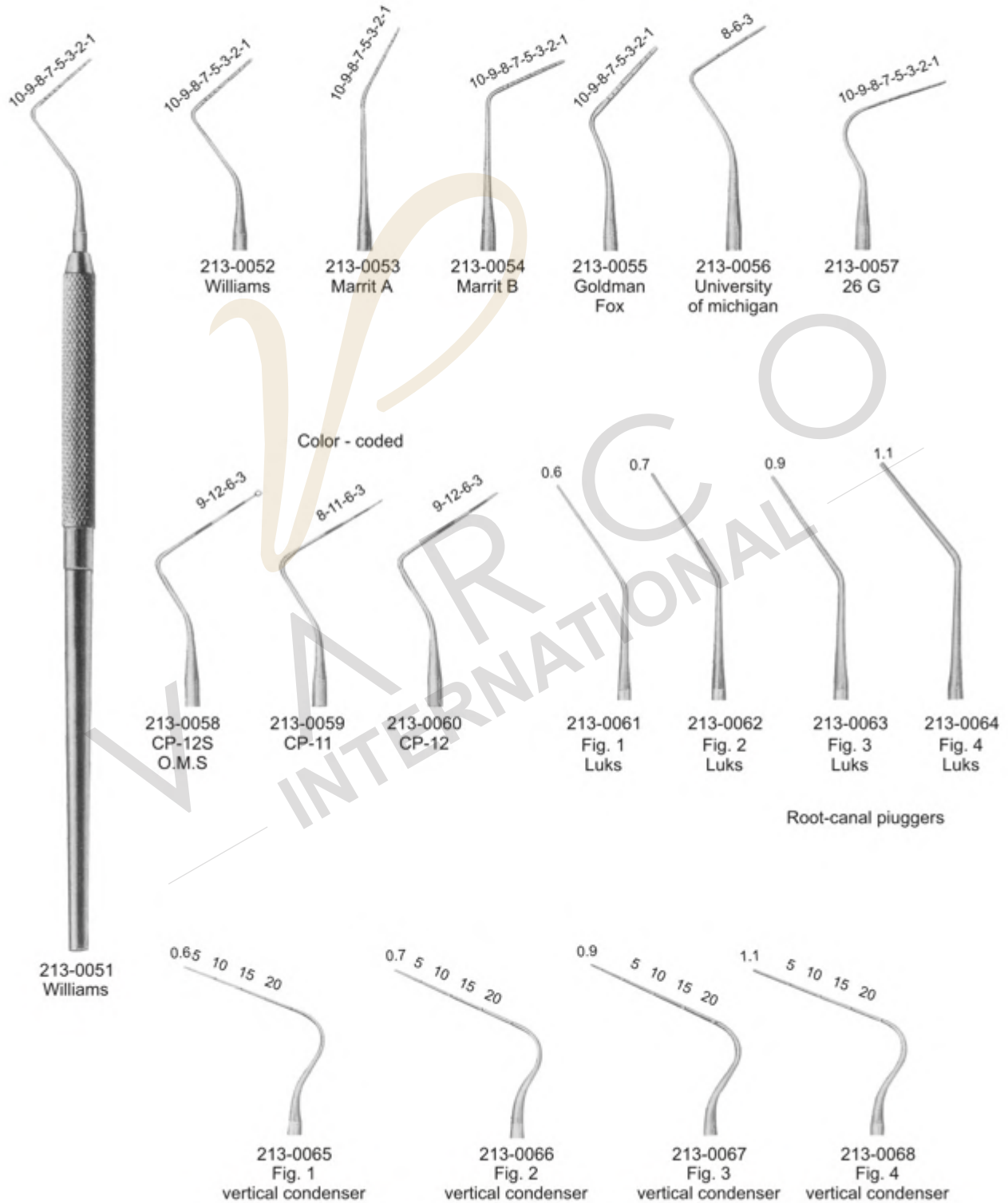



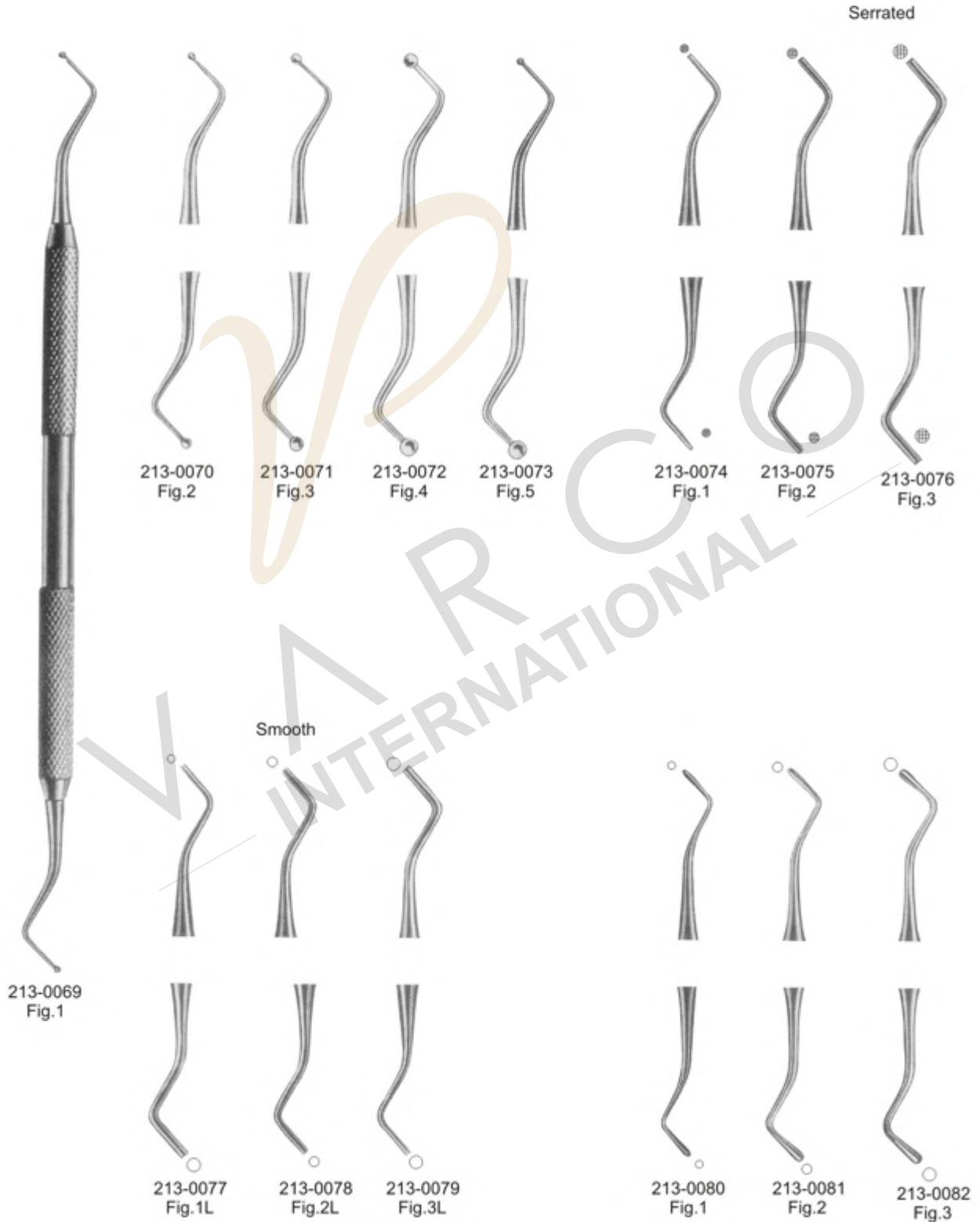

## ●●● FILLING INSTRUMENTS

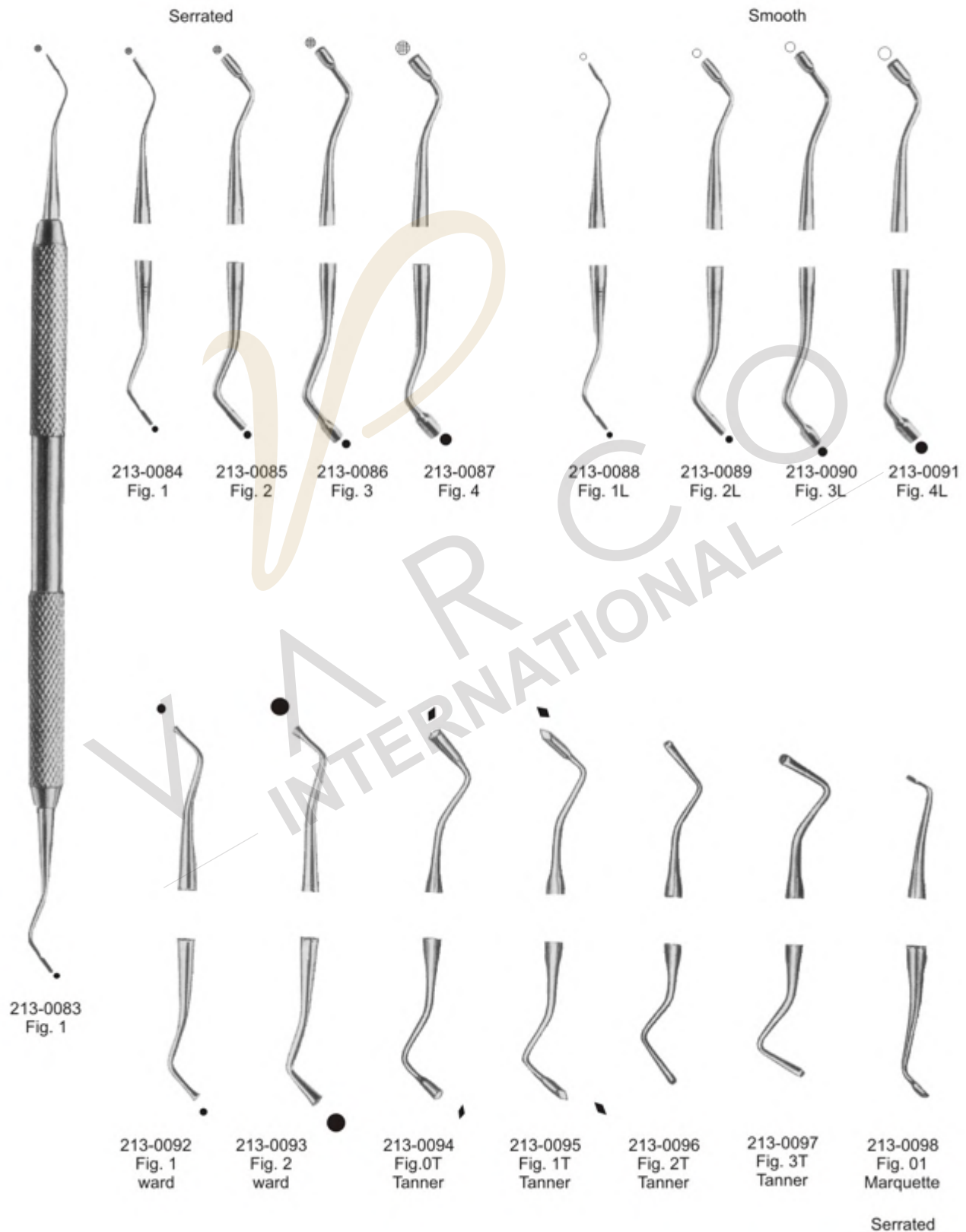

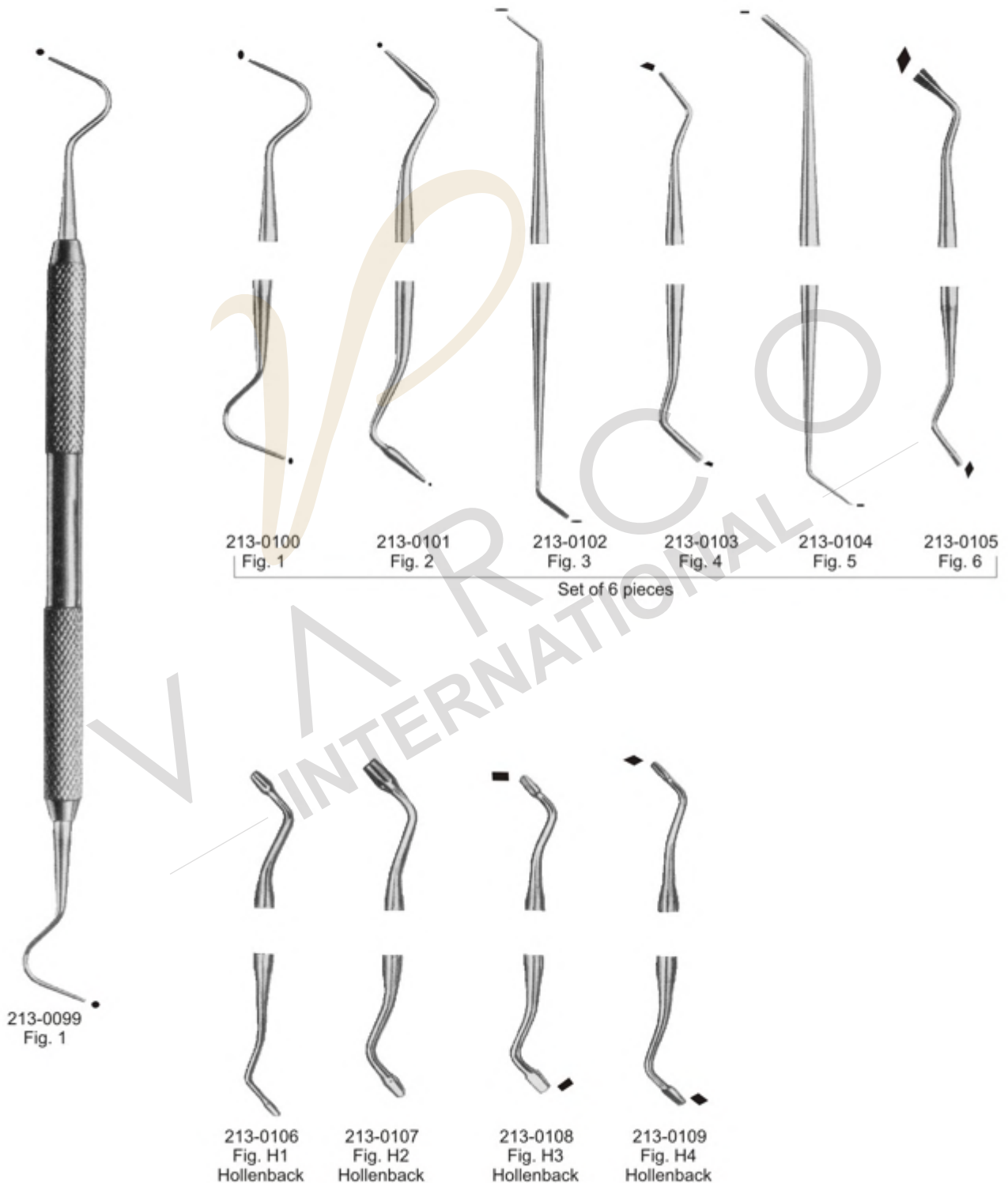

●●● FILLING INSTRUMENTS PLASTIC FILLING INSTRUMENTS



213-0110  
Fig. 1  
westcott

Plastic Filling Instruments

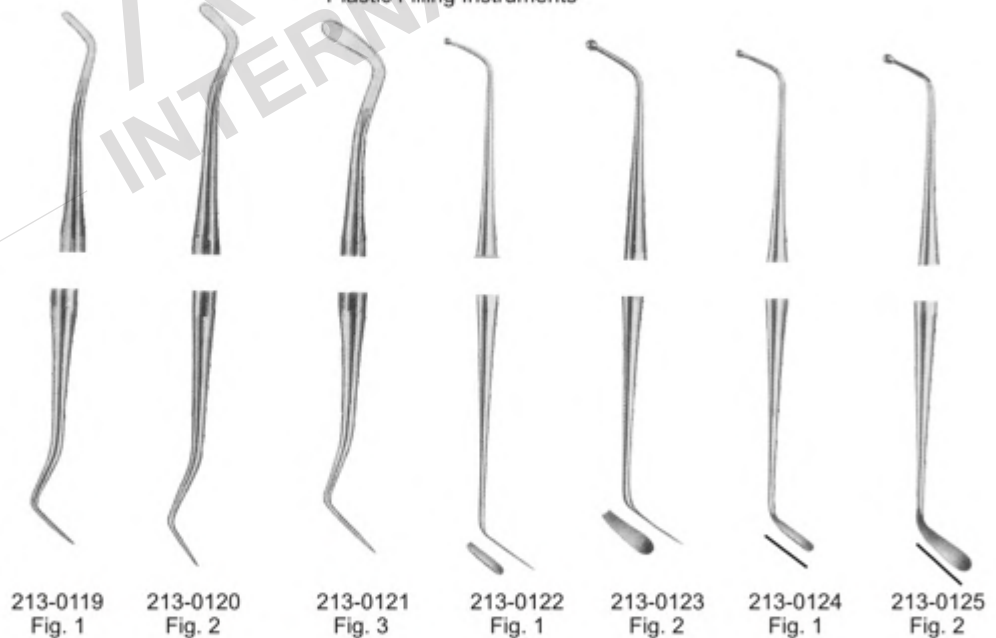

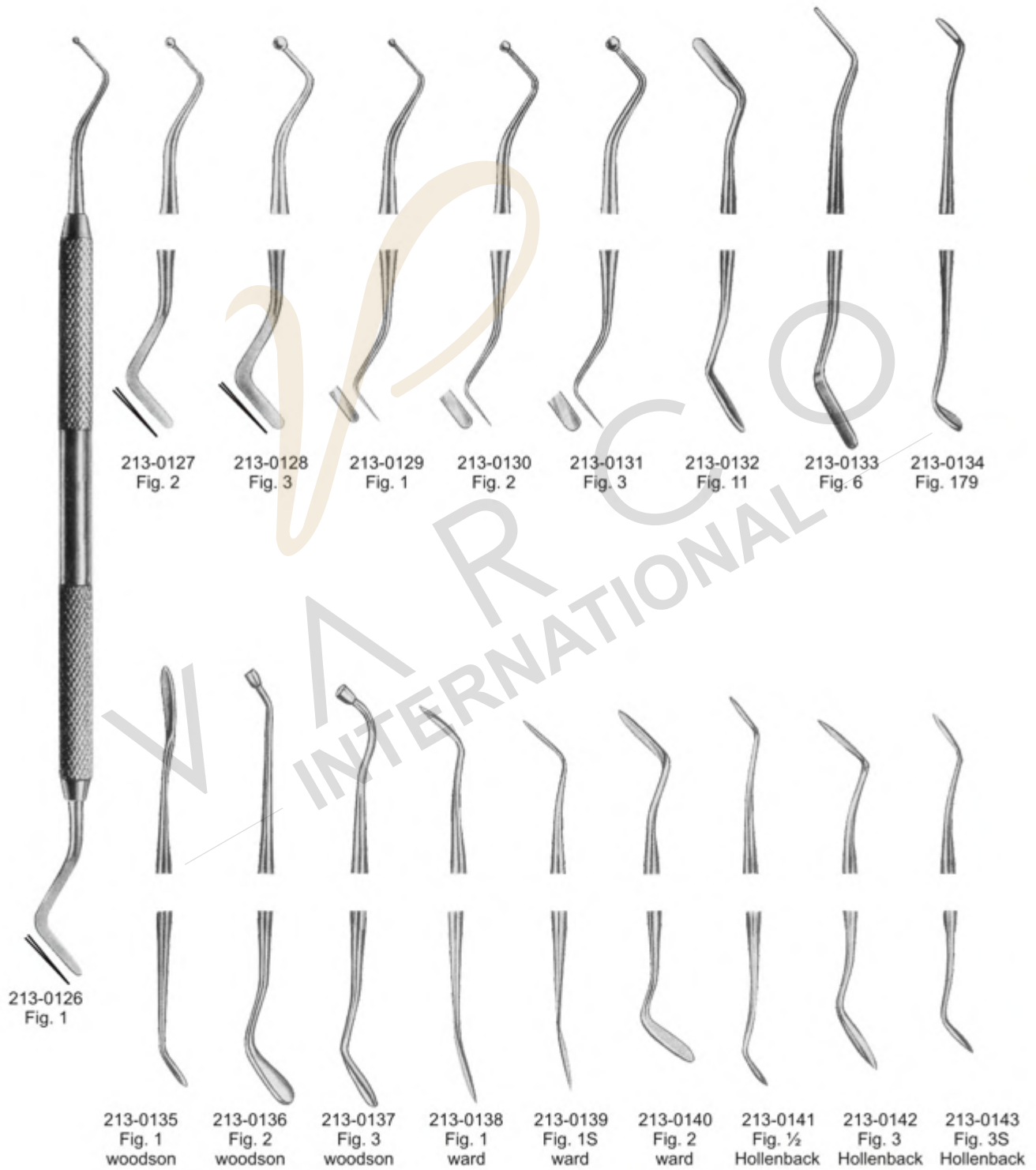

●●● AMALGAM CARVERS OPERATIVE INSTRUMENTS

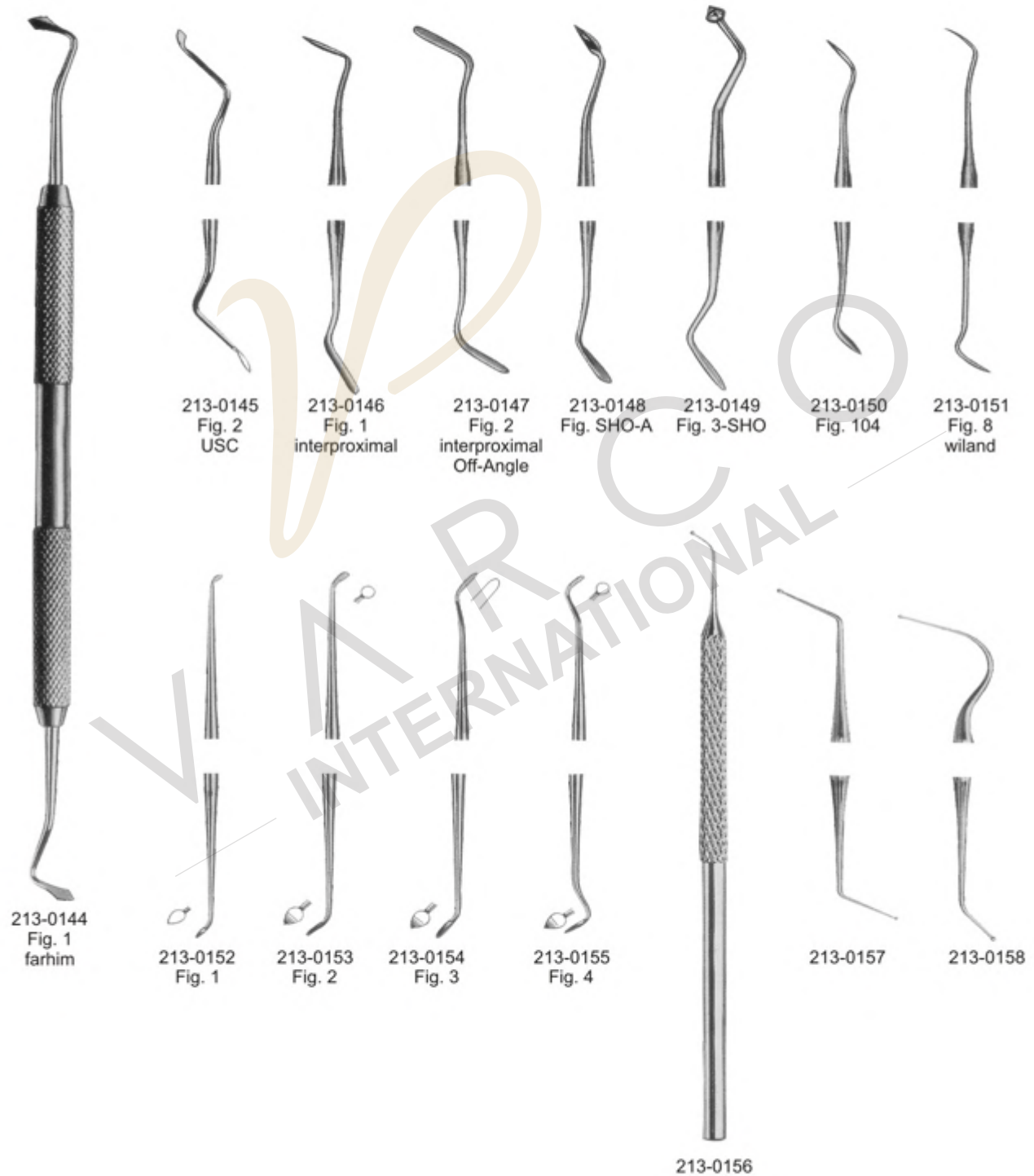

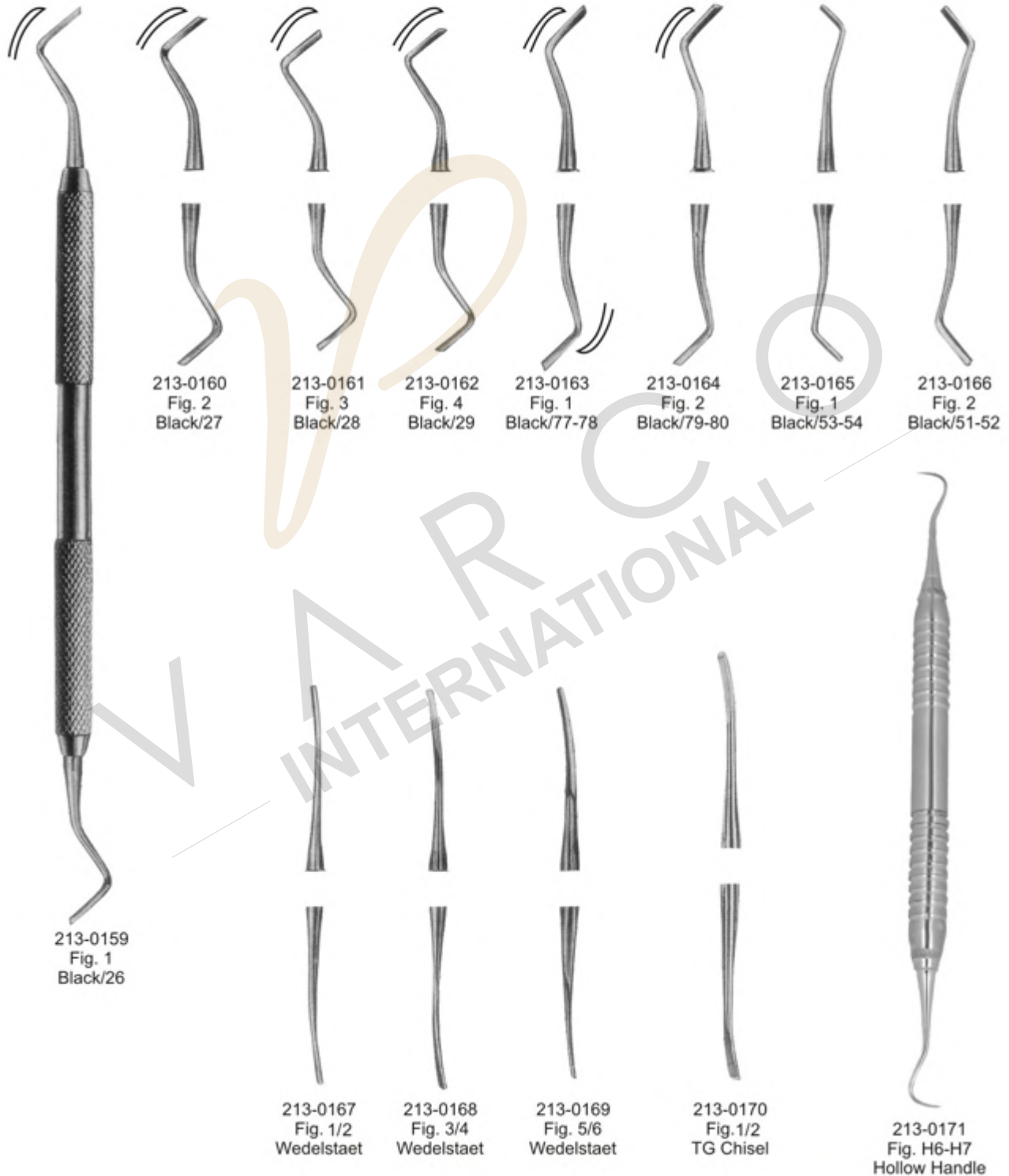

## ●●● EXCAVATORS

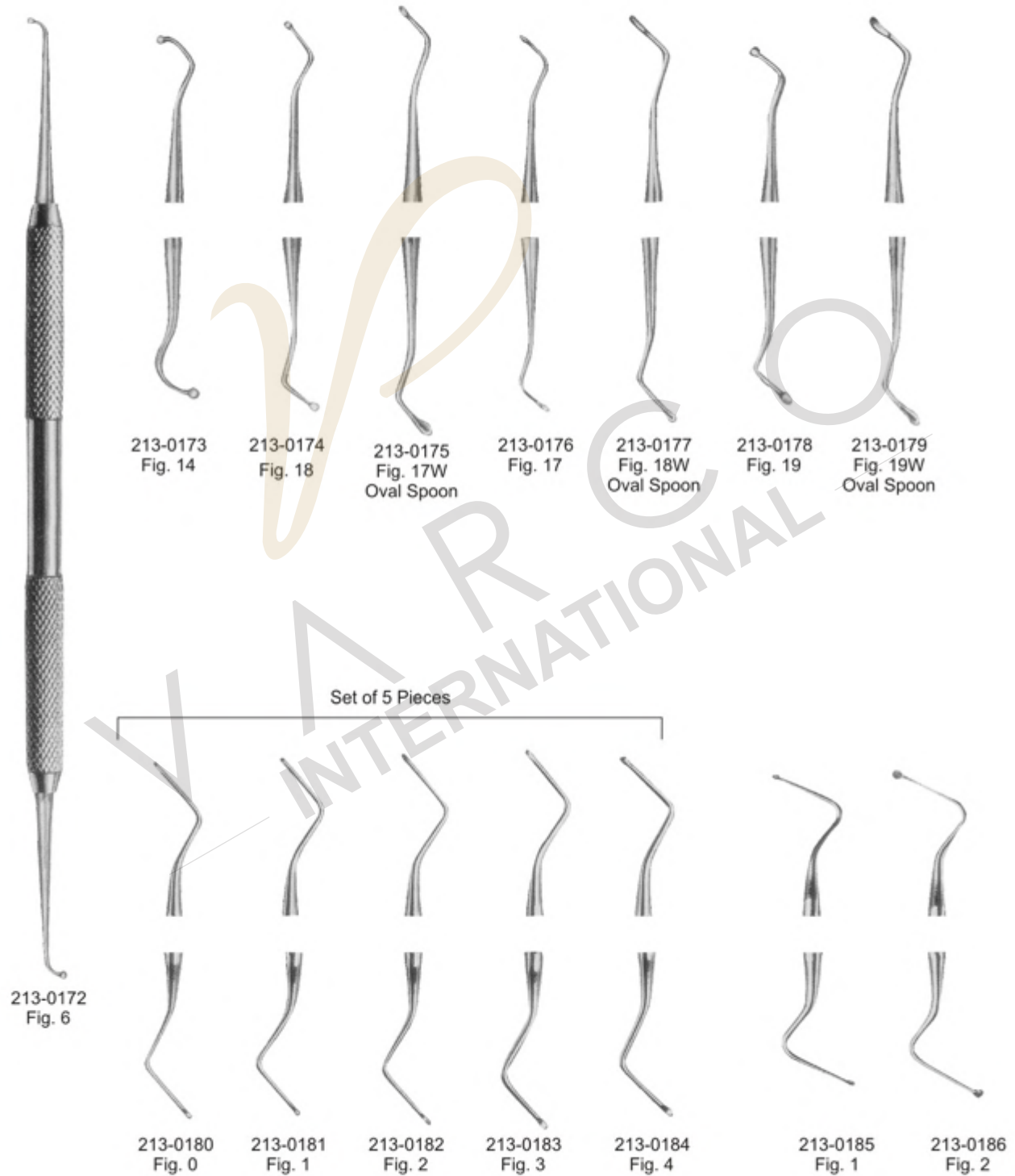



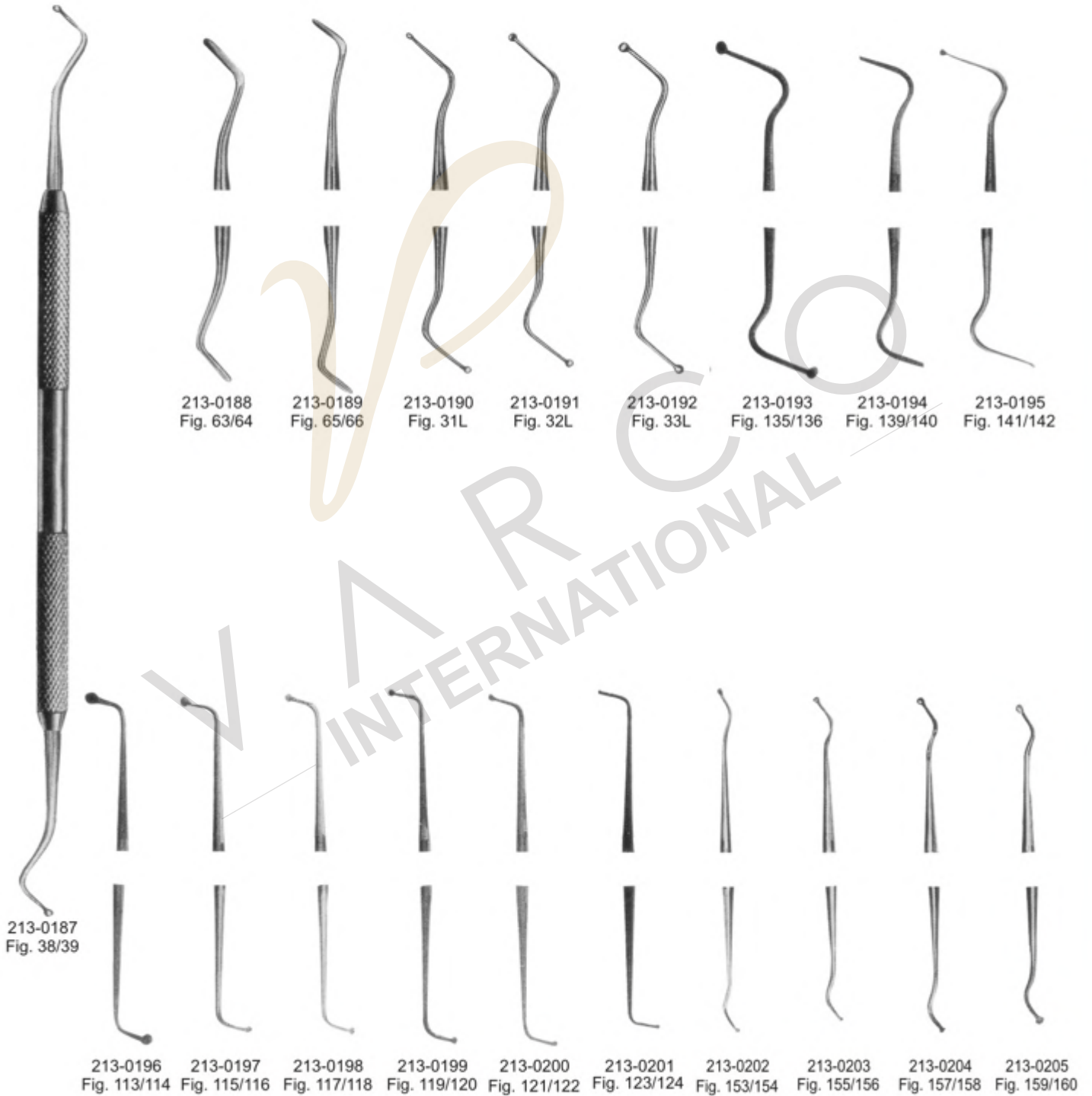

●●● EXCAVATORS ENGLISH PATTERN

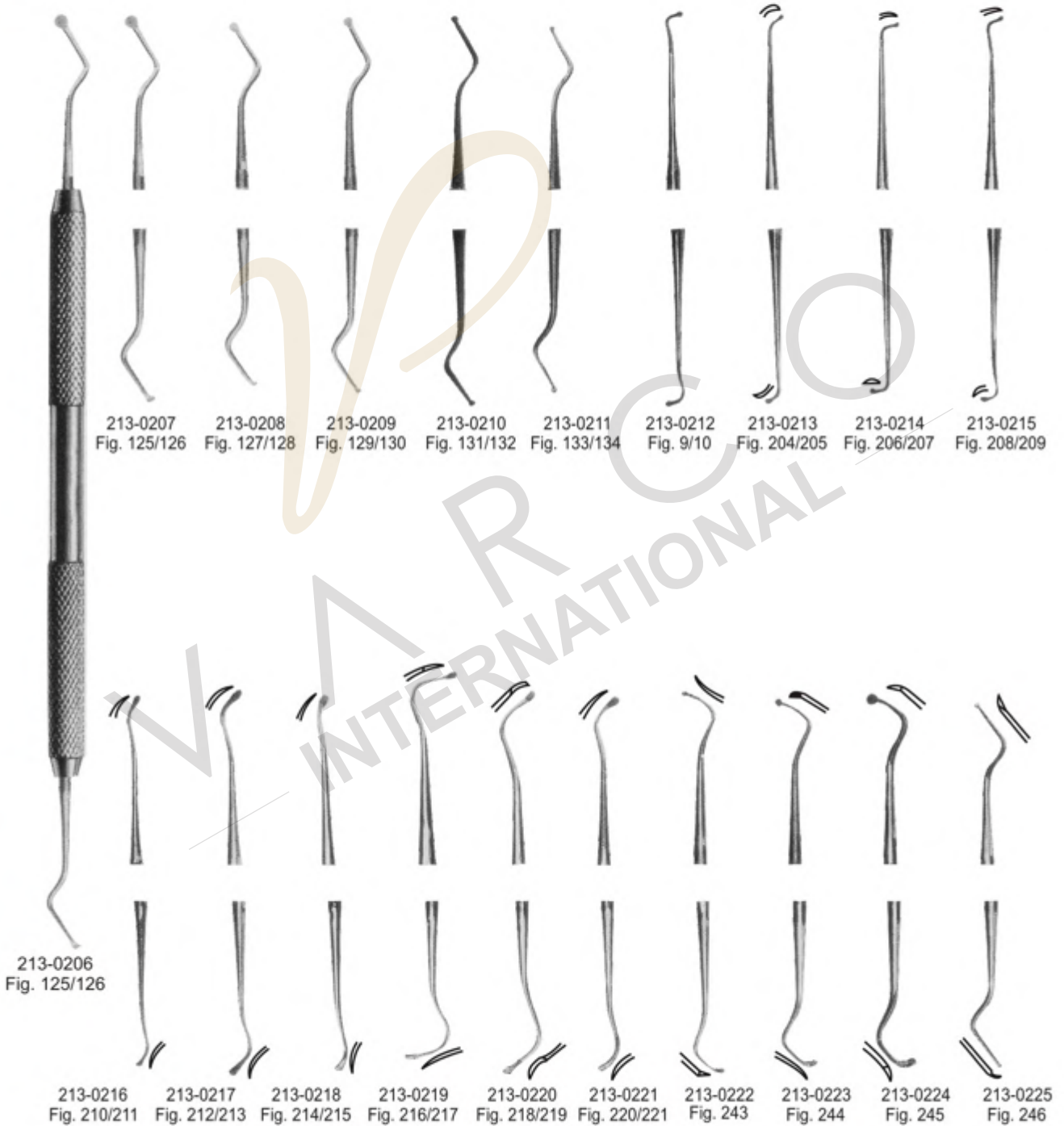



213-0226  
Fig. M9  
Molt

213-0227  
Fig. 1  
Hopkins

213-0228  
Fig. 2  
Hopkins

213-0229  
Fig. 3  
Mead

213-0230  
Fig. 3  
Prichard

213-0231  
Fig. Pr3  
Freer

213-0232  
Fig. 16  
Freer

## ●●● BONE FILES

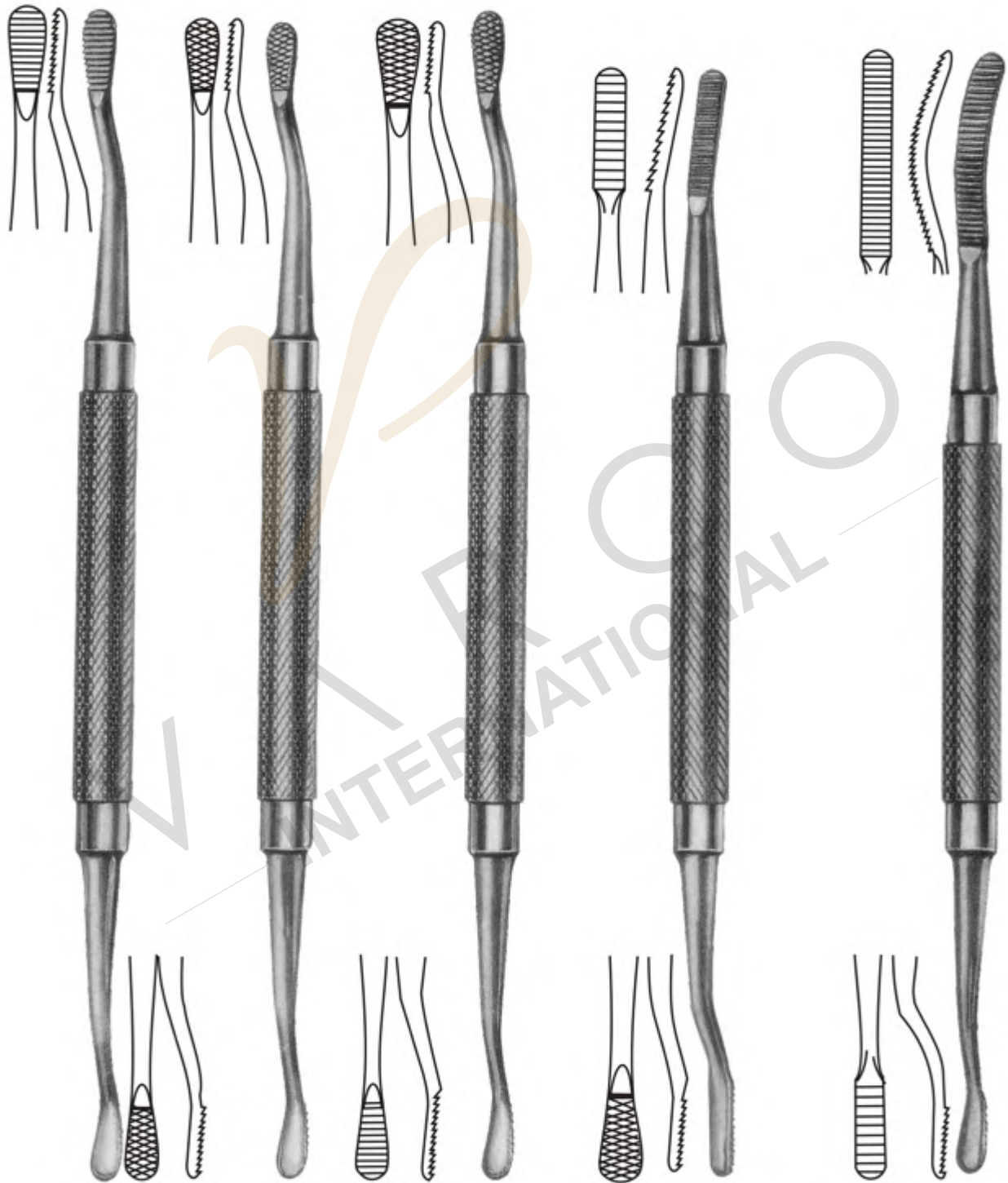

213-0233  
Fig. 12 CA

213-0234  
Fig. 12A

213-0235  
Fig. 12  
Howard

213-0236  
Fig. 33

213-0237  
Fig. 45  
Miller

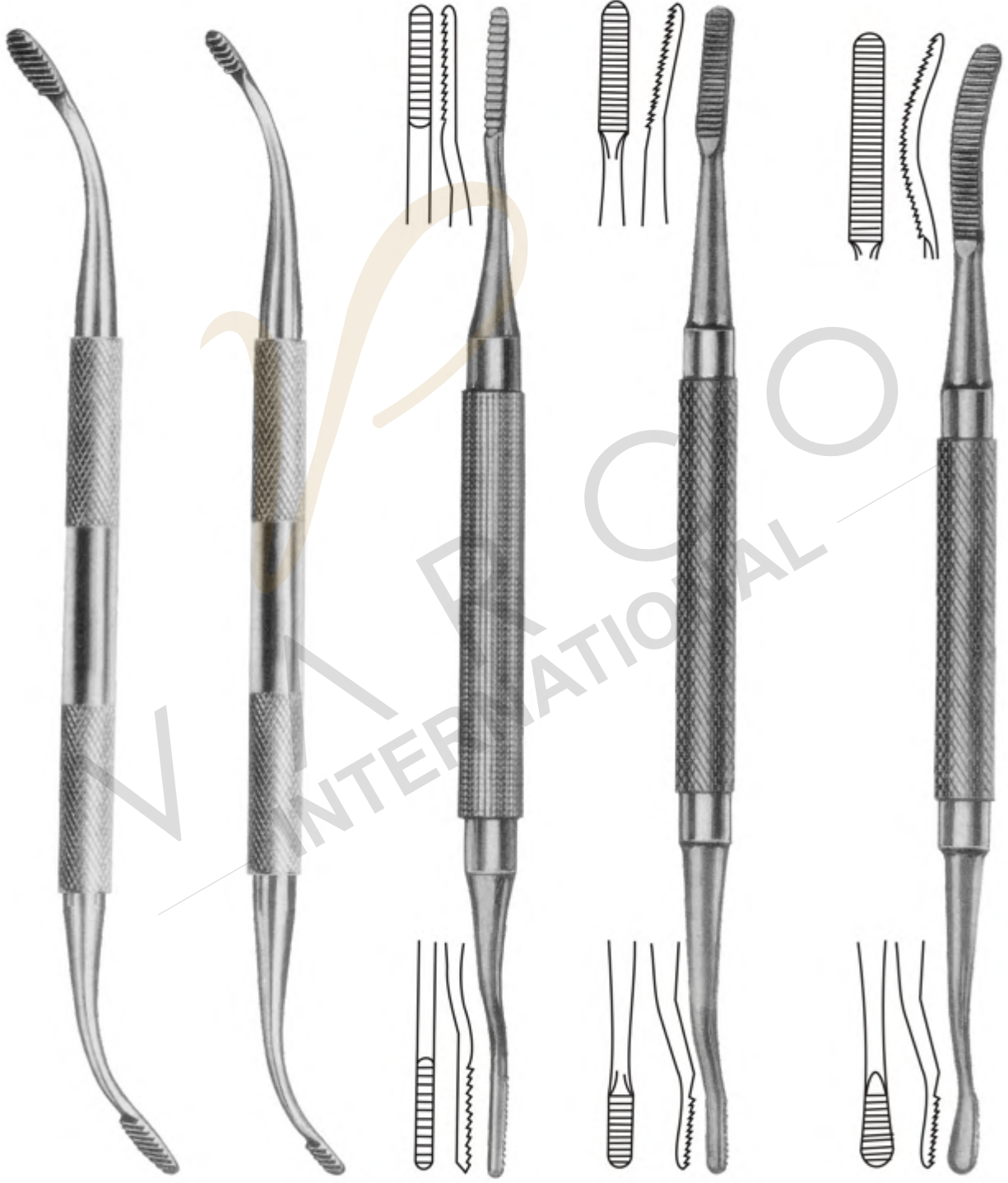

213-0238  
Fig. 1  
Wahl

213-0239  
Fig. 2  
Wahl

213-0240  
Fig. 1  
Polokoff

213-0241  
Fig. 64  
Miller

213-0242  
Fig. 10  
Miller

●●● BONE CURETTES PERIODONTIA INSTRUMENTS

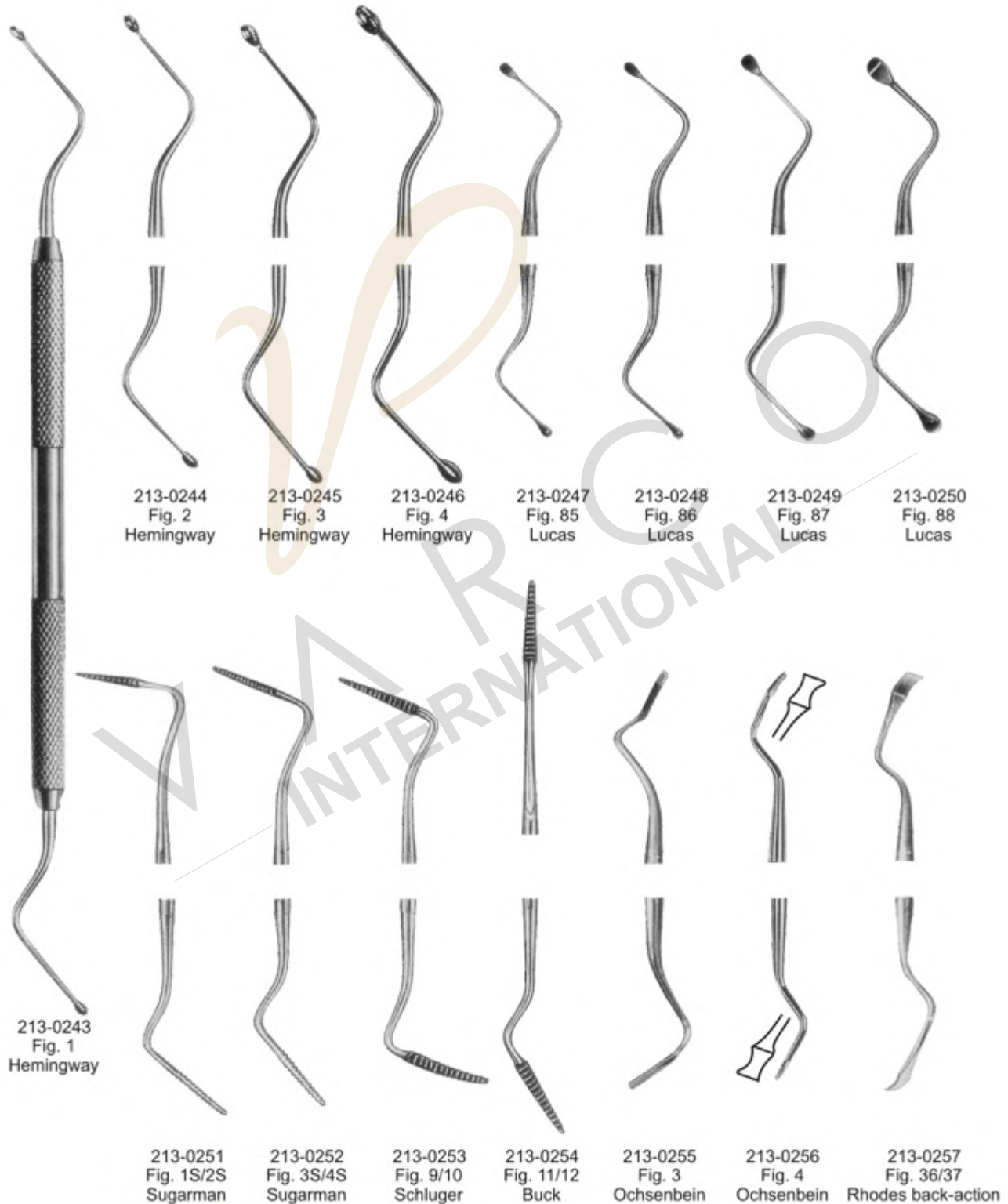

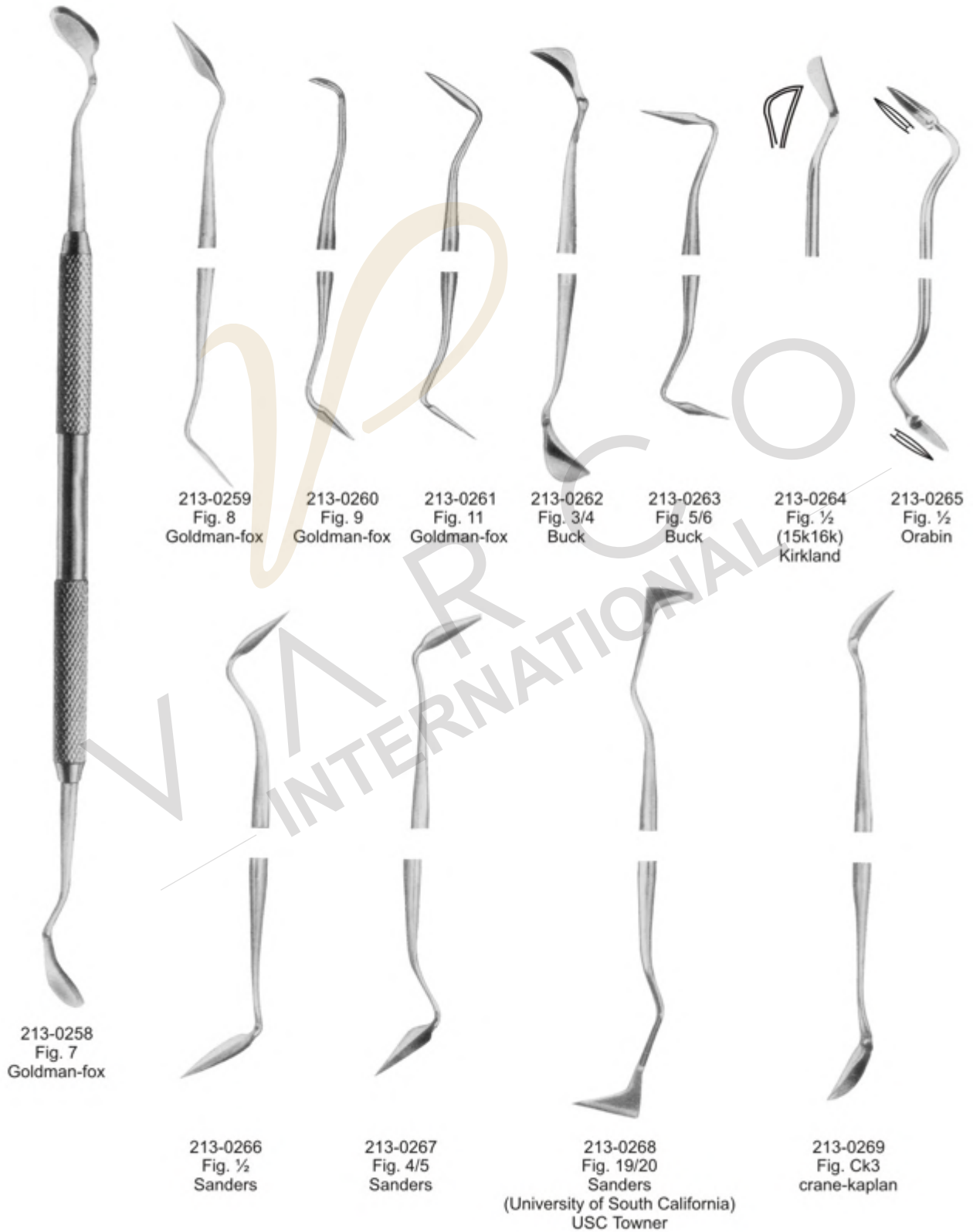

## ●●● PERIODONTIA INSTRUMENTS

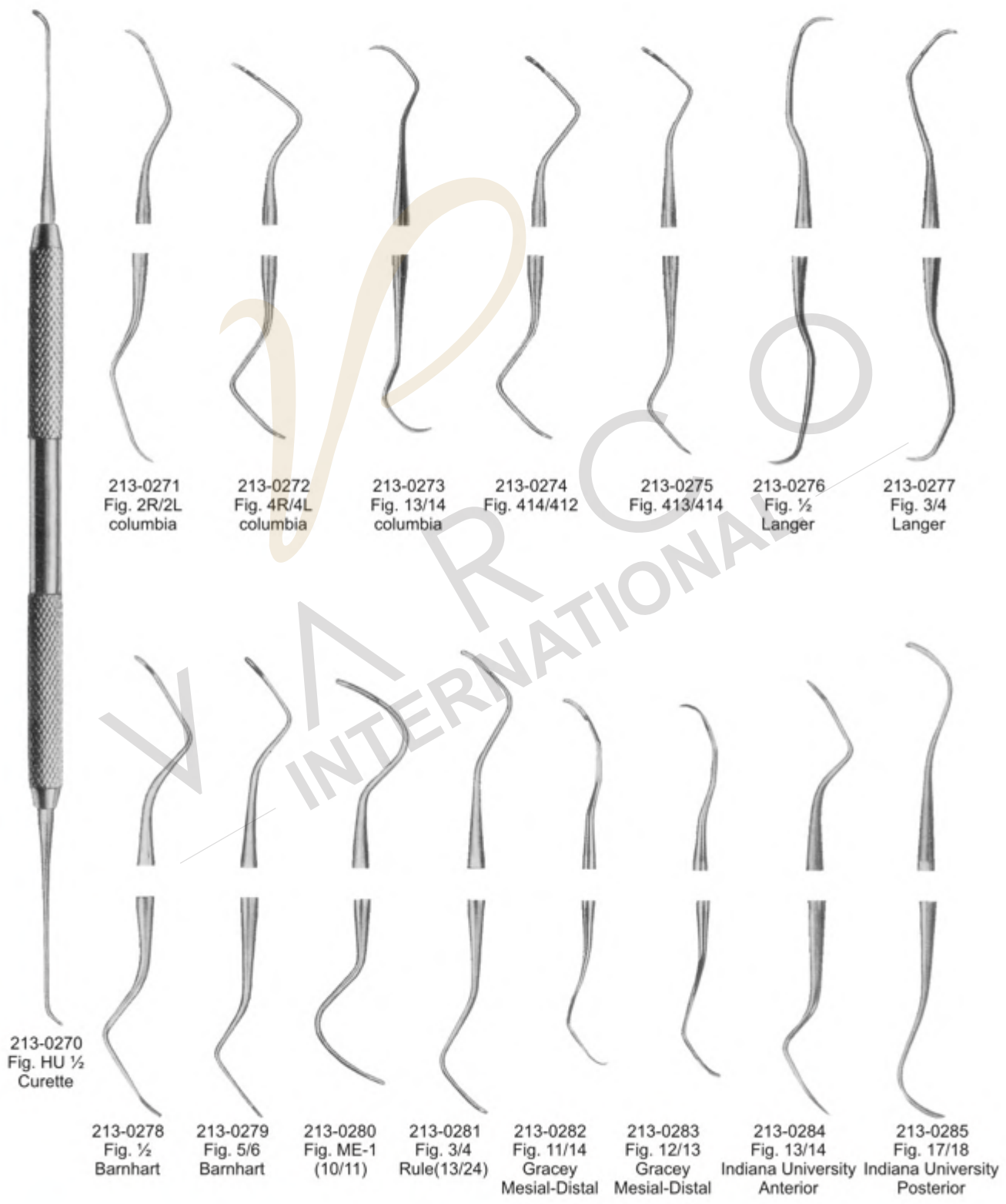

213-0271  
Fig. 2R/2L  
columbia

213-0272  
Fig. 4R/4L  
columbia

213-0273  
Fig. 13/14  
columbia

213-0274  
Fig. 414/412

213-0275  
Fig. 413/414

213-0276  
Fig. ½  
Langer

213-0277  
Fig. ¾  
Langer

213-0270  
Fig. HU ½  
Curette

213-0278  
Fig. ½  
Barnhart

213-0279  
Fig. 5/6  
Barnhart

213-0280  
Fig. ME-1  
(10/11)

213-0281  
Fig. ¾  
Rule(13/24)

213-0282  
Fig. 11/14  
Gracey  
Mesial-Distal

213-0283  
Fig. 12/13  
Gracey  
Mesial-Distal

213-0284  
Fig. 13/14  
Indiana University  
Anterior

213-0285  
Fig. 17/18  
Indiana University  
Posterior



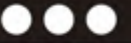

## ●●● PERIODONTIA INSTRUMENTS

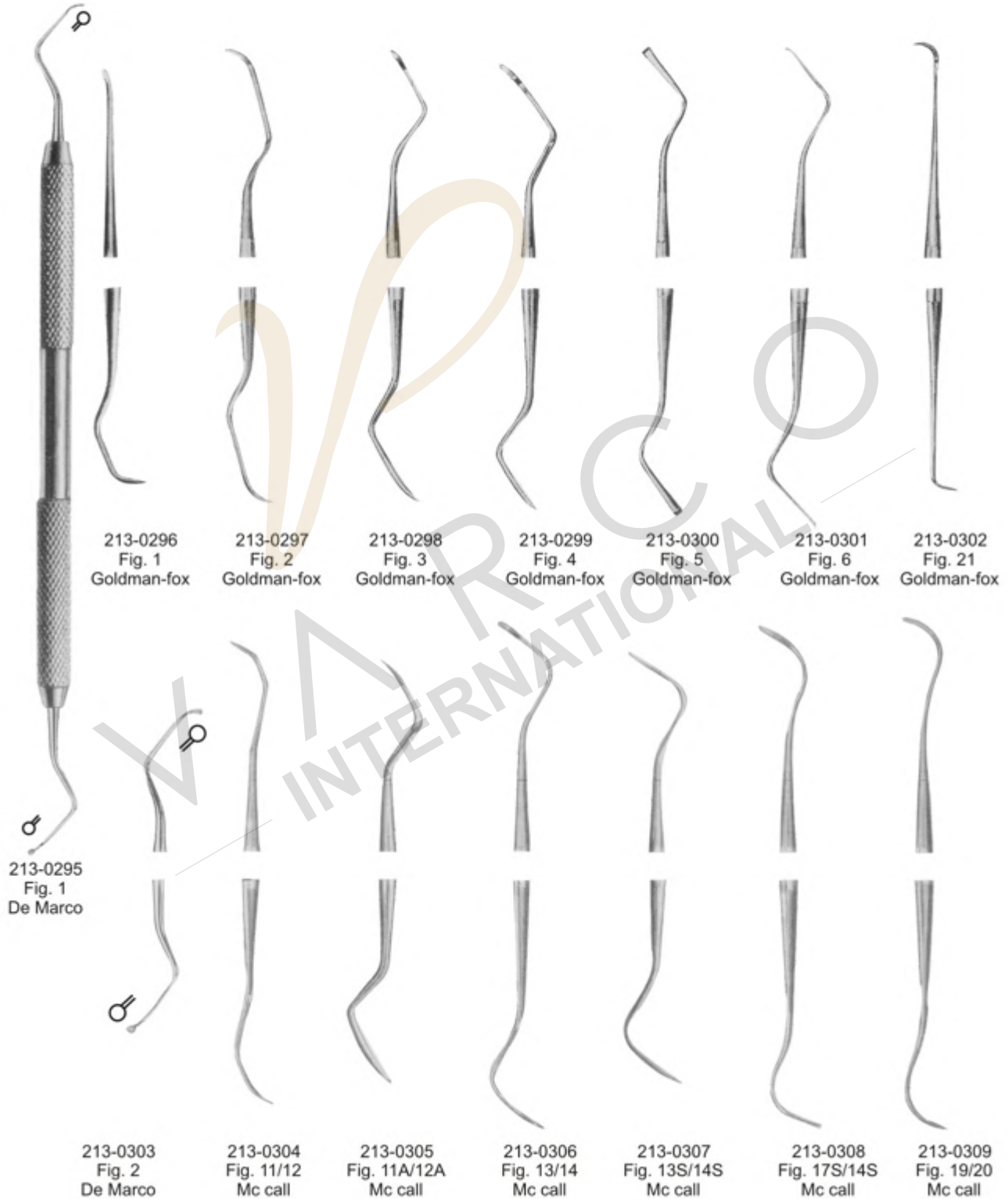

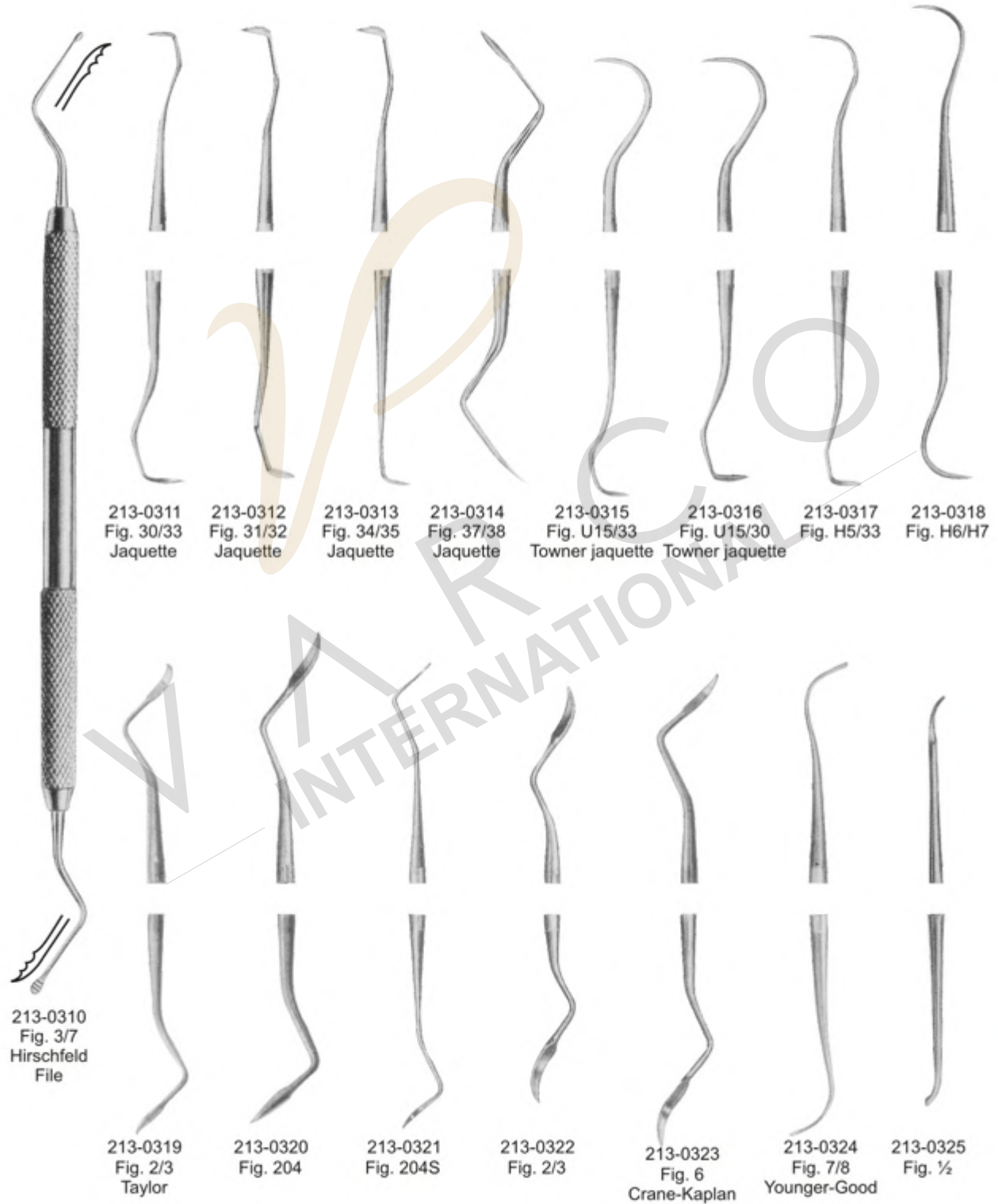

## ●●● PERIODONTIA INSTRUMENTS

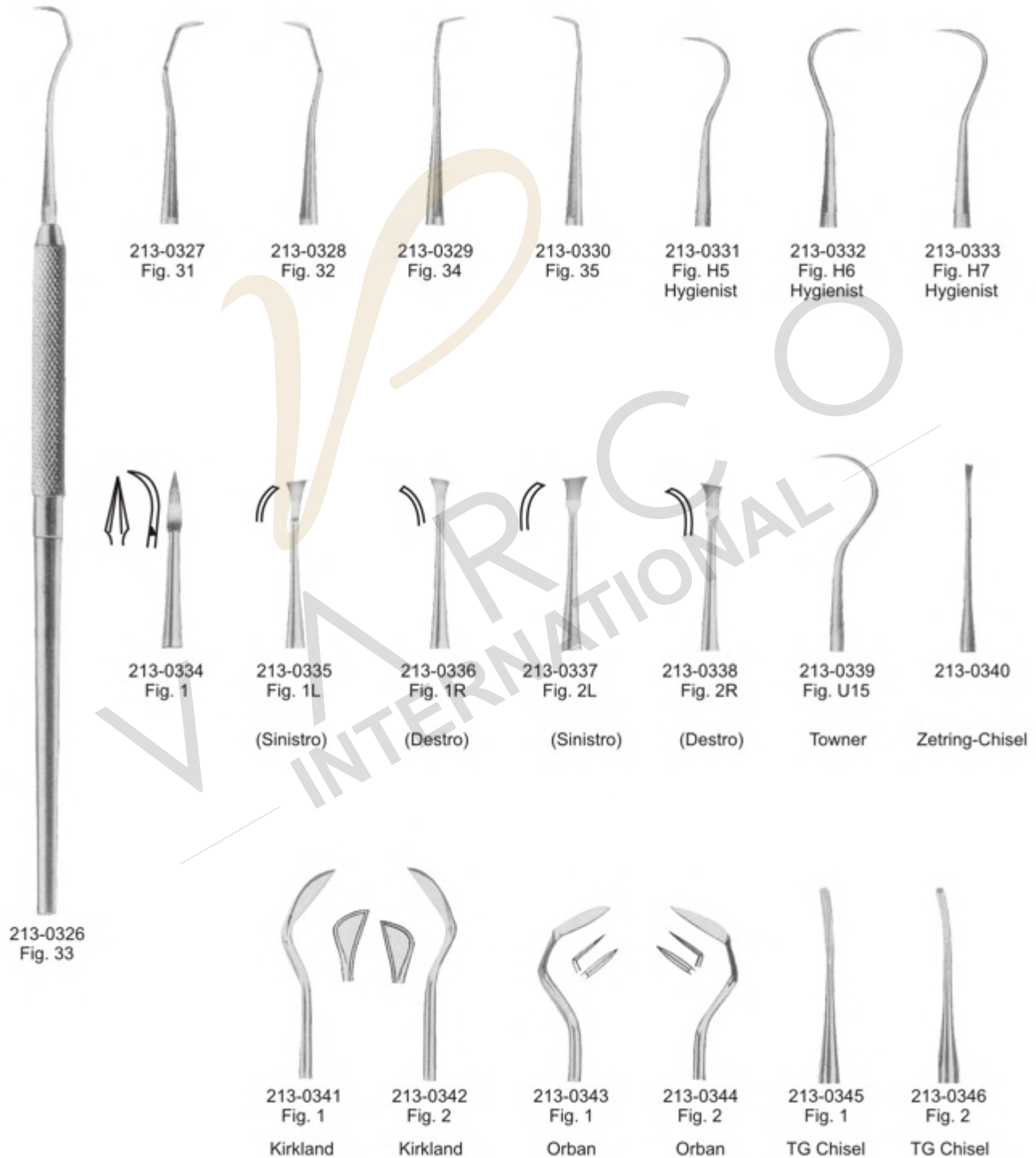



## ●●● WEX AND MODELLING CARVERS





## ●●● WEX AND MODELLING CARVERS



213-0374  
Fig. 1  
P. K.thomas



213-0375  
Fig. 2  
P. K.thomas



213-0376  
Fig. 3  
P. K.thomas



213-0377  
Fig. 4  
P. K.thomas



213-0378  
Fig. 5  
P. K.thomas





214-0001  
Fig. 1  
Fahnenstock  
12.5 cm

214-0002  
Fig. 1  
Lessmann  
12.5 cm

214-0003  
Fig. 1  
Con Scodelina

214-0004  
Fig. 2  
Fahnenstock

214-0005  
Fig. 2  
Lessmann

214-0006  
Fig. 2  
Con Scodelina

## ●●● SPATULAS FOR PLASTER AND ALGINATE



214-0007  
cm 17



214-0008  
cm 17 Gritman



214-0009  
cm 19.5

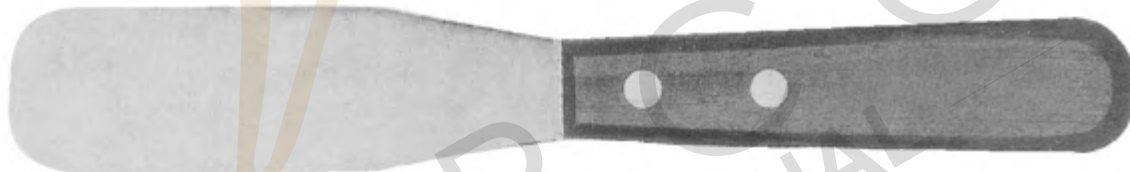

214-0010  
cm 21.5

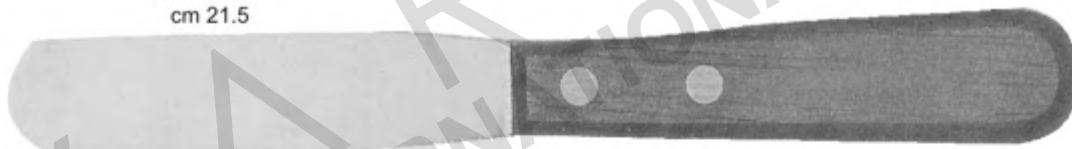

214-0011  
cm 20.5

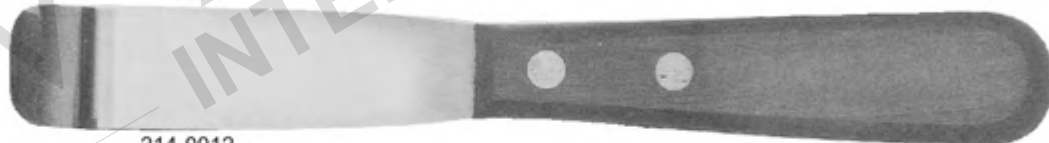

214-0012  
cm 19.5

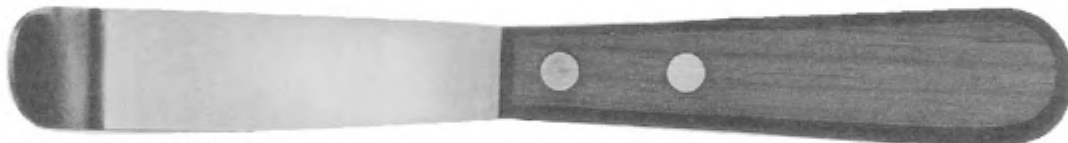

214-0013  
cm 20

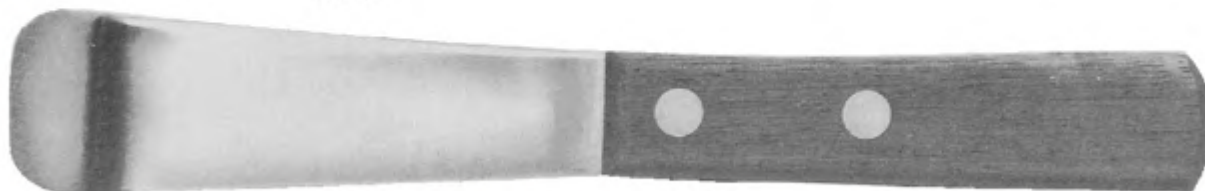

214-0014  
cm 22.5



## ●●● DENTAL CARTRIDGE SYRINGES

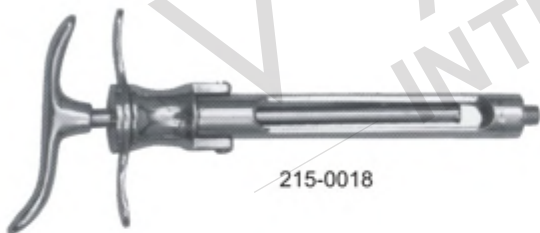



215-0022



215-0023

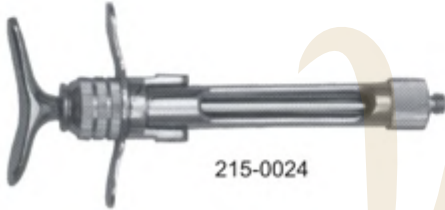

215-0024



215-0025

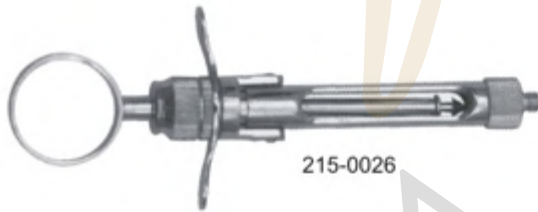

215-0026



215-0027



215-0028

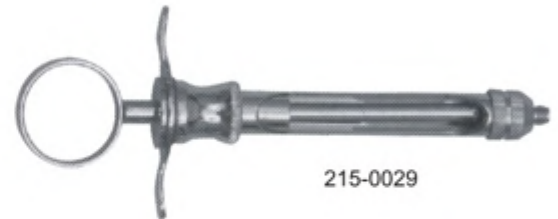

215-0029



215-0030



215-0031

● ● ● CHIP BLOWERS, WATER SYRINGES



Chip bolwer

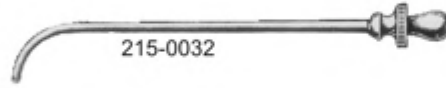

215-0032



215-0033

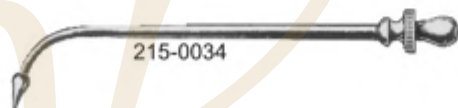

215-0034

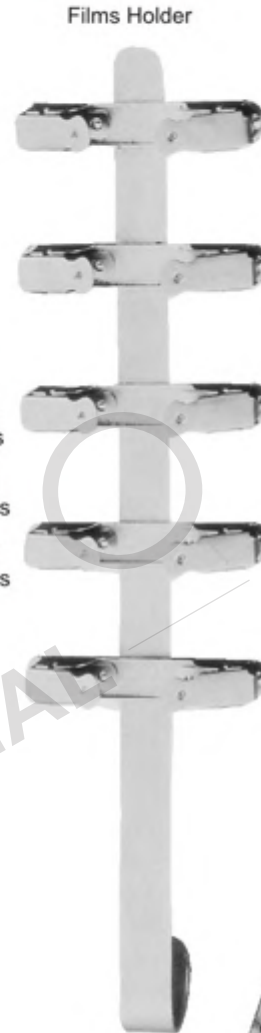

Films Holder

215-0035  
For 6 Films

215-0036  
For 10 Films

215-0037  
For 14 Films

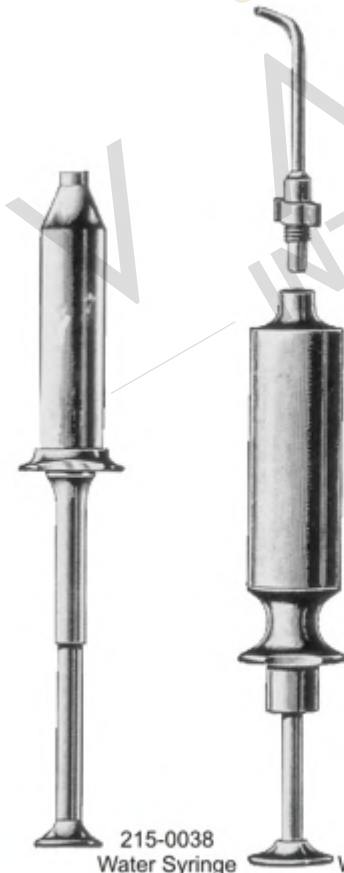

215-0038  
Water Syringe

215-0039  
Water Syringe

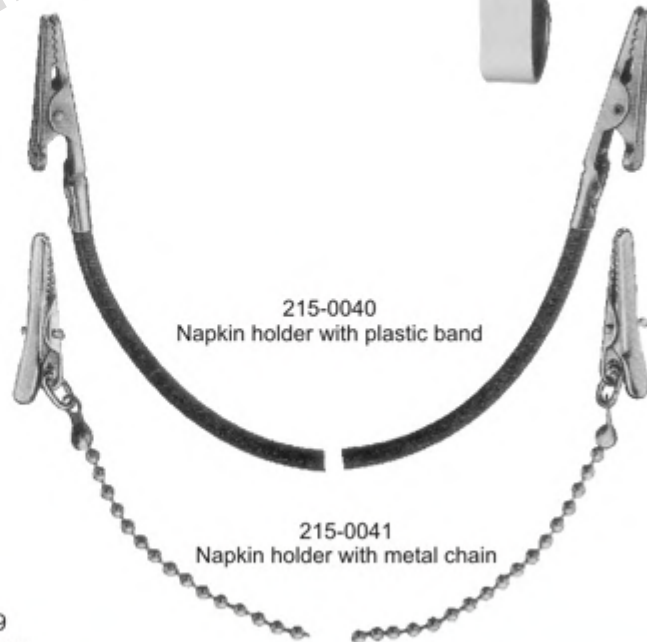

215-0040  
Napkin holder with plastic band

215-0041  
Napkin holder with metal chain



215-0042-5mm  
215-0043-6mm  
215-0044-7mm  
Ivory



215-0045  
Ivory 8 N



215-0046  
Ivory 8



215-0047  
Siqveland-narrow  
215-0048  
Siqveland-wide



215-0049  
Fig. 1  
Toffemire-universal



215-0050  
Fig. 2  
Toffemire-senior



215-0051  
Fig. 3  
Toffemire-junior



215-0052  
Fig. 2  
Didher 8



215-0053  
Ivory



215-0054  
Ivory



215-0055  
Ivory separator

## ●●● CROWN INSTRUMENTS

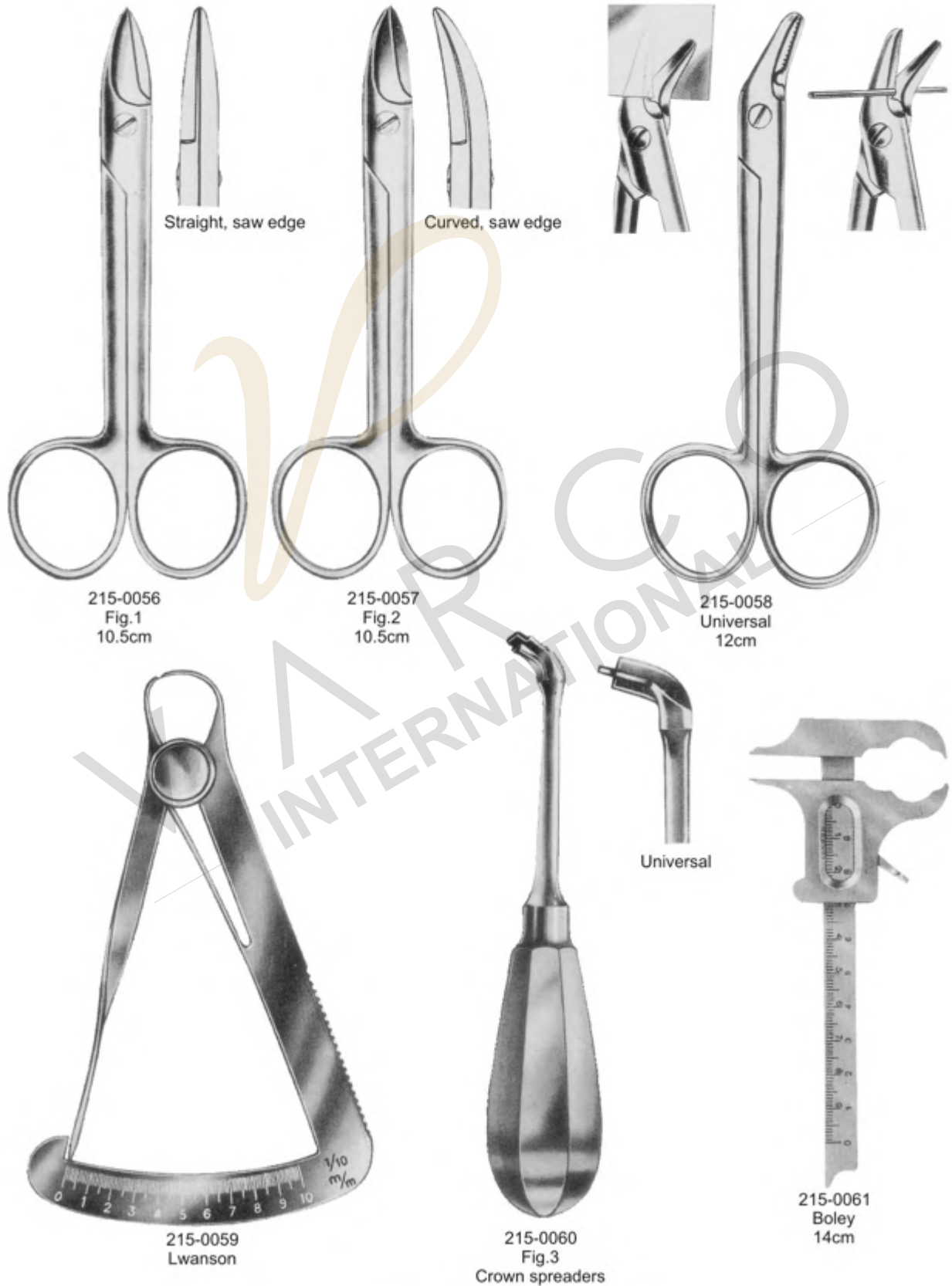



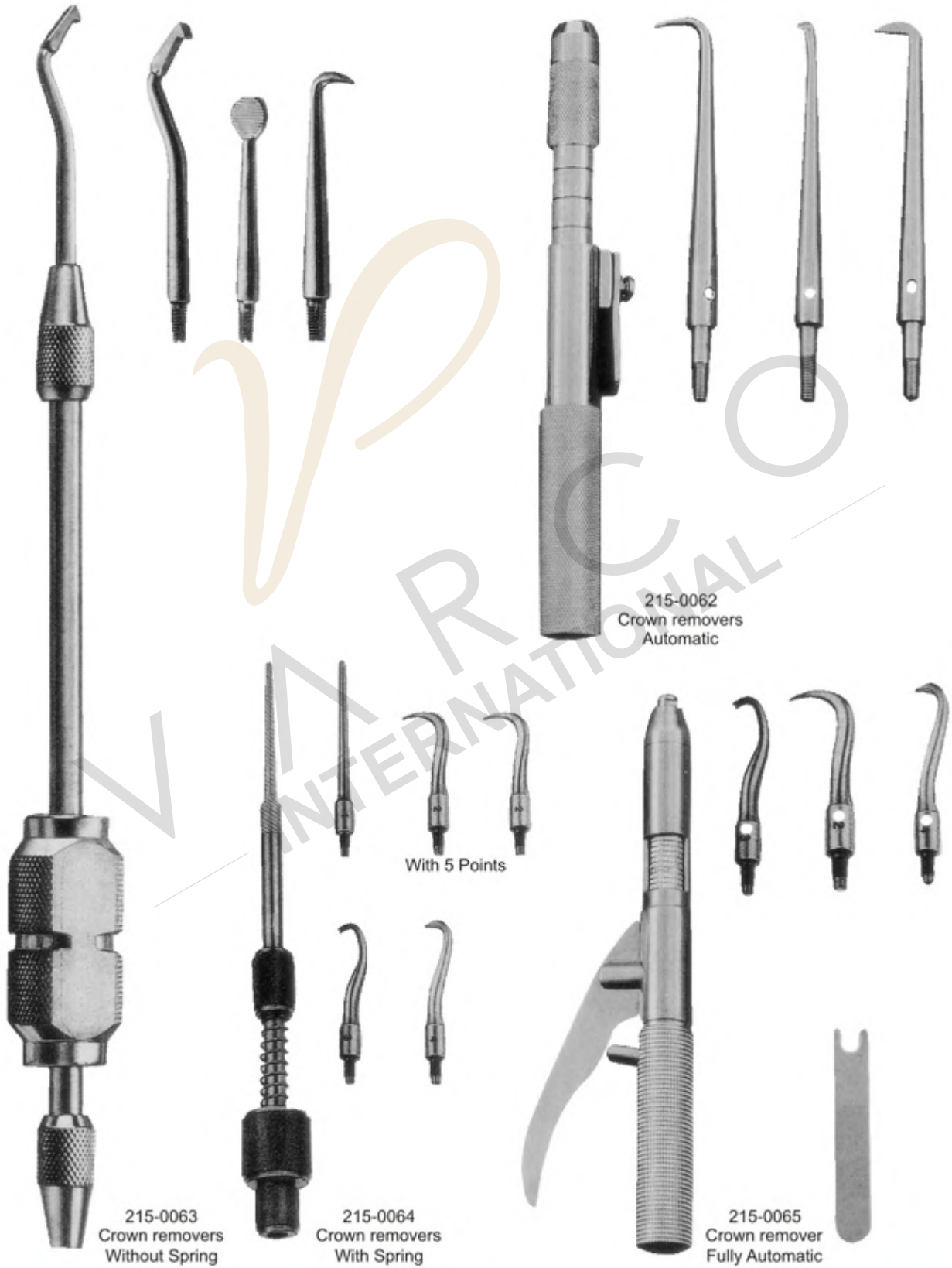

## ●●● CROWN INSTRUMENTS



215-0066  
Articulating Paper Forcep  
15cm



215-0067  
Miller  
15cm



215-0068  
Crown Spreader



215-0069  
Vernier Gauge Caliper  
0mm to 80mm

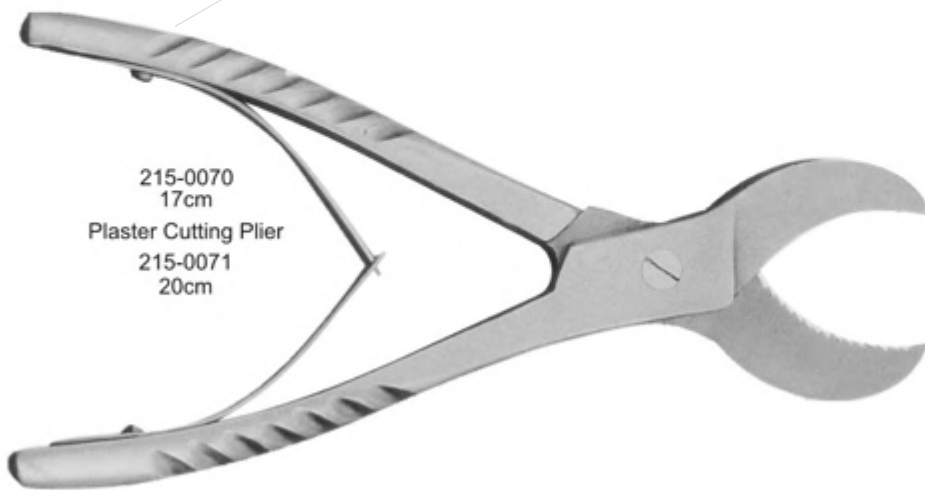

215-0070  
17cm  
Plaster Cutting Plier  
215-0071  
20cm



215-0072  
Arch Turret with 5 wire-slots  
.016", .017", .018", .020" and .022"

**Available in Set of 8**  
**Code # Set - A001**

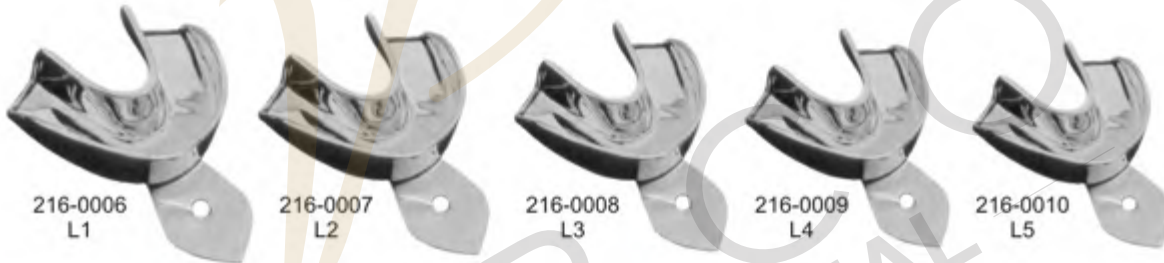
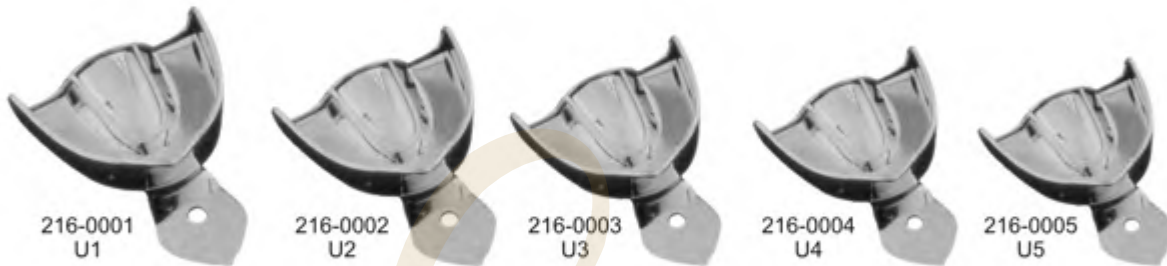

All the above impression trays are available in these 4 sizes

| UPPER |    | U1 | U2 | U3 | U4 | U5 | Lower |    | L1 | L2 | L3 | L4 | L5 |
|-------|----|----|----|----|----|----|-------|----|----|----|----|----|----|
|       | A  | 62 | 60 | 53 | 54 | 52 |       | A  | 63 | 61 | 57 | 60 | 53 |
| B     | 63 | 75 | 73 | 69 | 68 | B  | 82    | 81 | 78 | 74 | 71 |    |    |

All Dimension are in mm

All Dimension are in mm

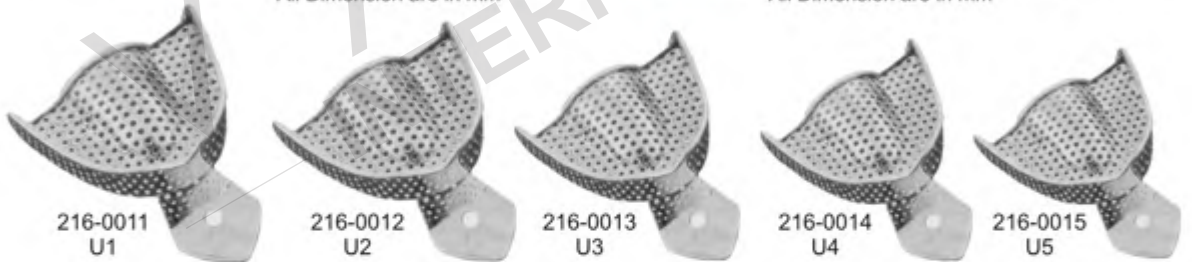

**Available in Set of 8**  
**Code # Set - A002**

## ●●● IMPRESSION TRAYS

Available in Set of 8  
Code # Set - A003

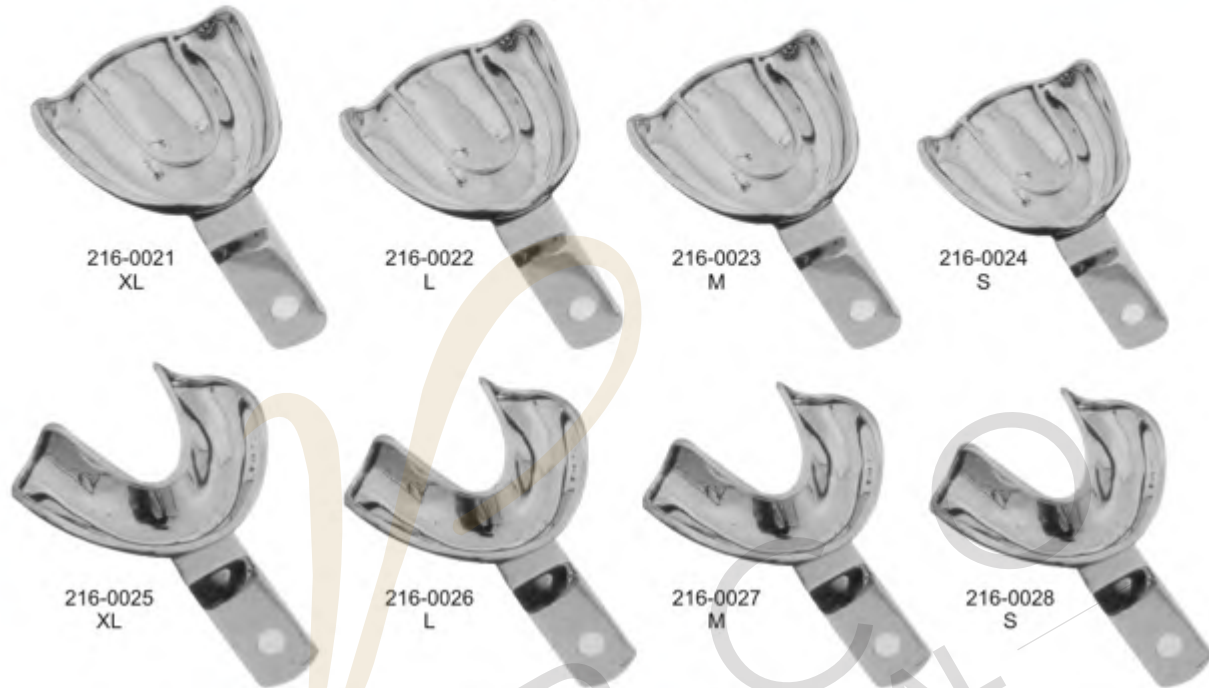

All the above impression trays are available in these 4 sizes

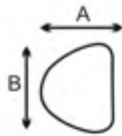

| UPPER |    | XL | L  | M  | S  |
|-------|----|----|----|----|----|
|       | A  | 70 | 67 | 64 | 60 |
| B     | 79 | 78 | 70 | 73 |    |

All Dimension are in mm

| LOWER |    | XL | L  | M  | S  |
|-------|----|----|----|----|----|
|       | A  | 64 | 64 | 60 | 57 |
| B     | 86 | 70 | 73 | 70 |    |

All Dimension are in mm

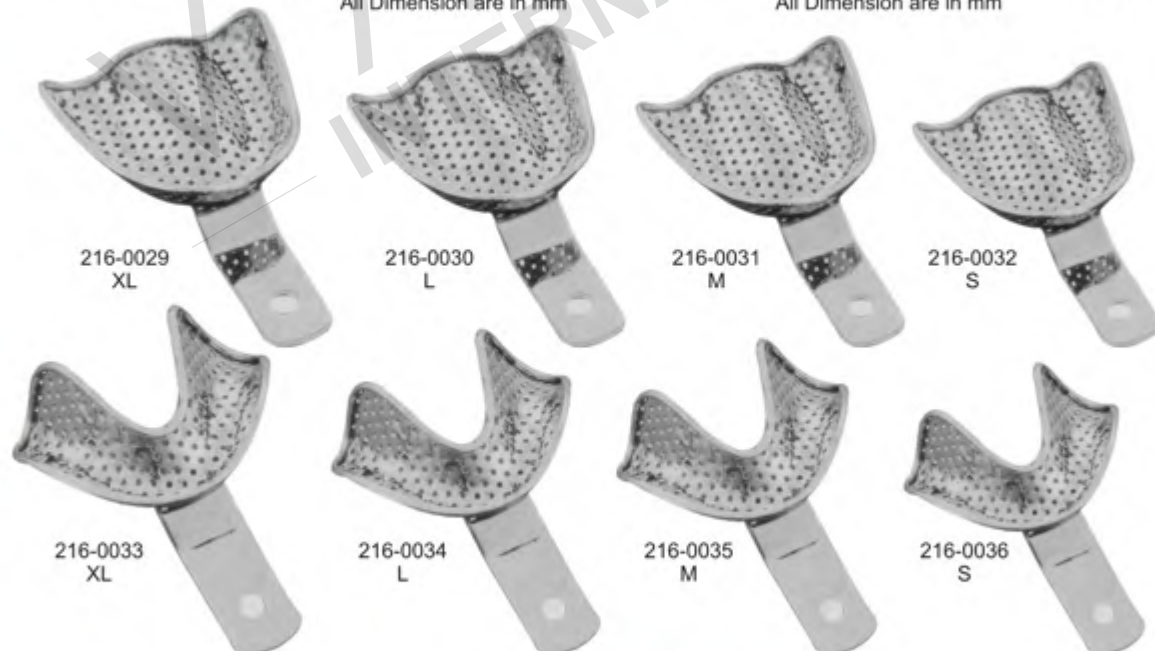
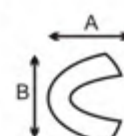

Available in Set of 8  
Code # Set - A004

**Available in Set of 6**  
**Code # Set - A005**

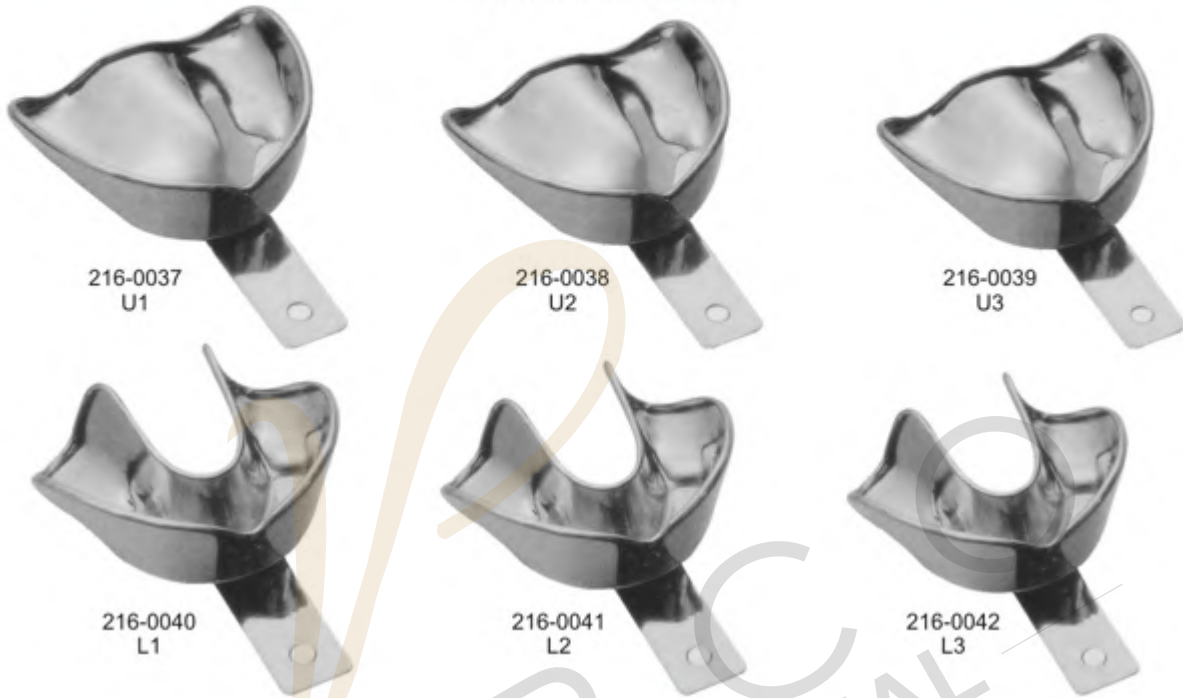

All the above impression trays are available in these 4 sizes

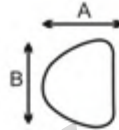

| LOWER | L1 | L2 | L3 |
|-------|----|----|----|
|       | A  | 67 | 64 |
| B     | 81 | 71 | 70 |

All Dimension are in mm

| LOWER | L1 | L2 | L3 |
|-------|----|----|----|
|       | A  | 60 | 57 |
| B     | 84 | 79 | 76 |

All Dimension are in mm



**Available in Set of 6**  
**Code # Set - A006**

## ●●● IMPRESSION TRAYS

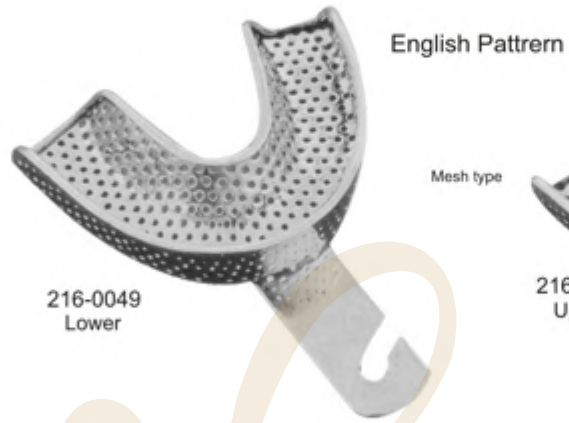

English Pattern



Mesh type

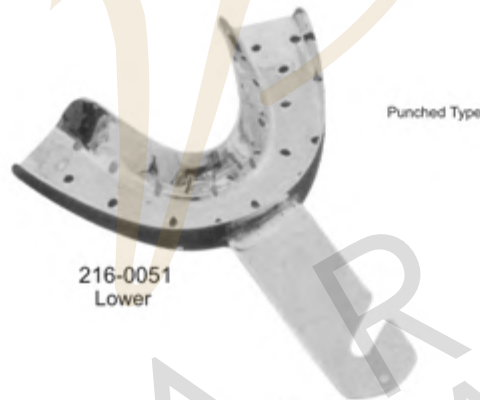

Punched Type



216-0052  
Upper



Solid Type



216-0054  
Upper

All the above impression trays are available in these 4 sizes

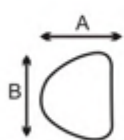

| UPPER | Size | A  | B  | C  |
|-------|------|----|----|----|
|       | 0    | 67 | 50 | 12 |
|       | 1    | 72 | 51 | 13 |
|       | 2    | 78 | 55 | 15 |
|       | 3    | 80 | 58 | 15 |

All Dimension are in mm

| LOWER | Size | A  | B  | C  |
|-------|------|----|----|----|
|       | 0    | 70 | 50 | 12 |
|       | 1    | 77 | 51 | 13 |
|       | 2    | 7  | 55 | 15 |
|       | 3    | 80 | 50 | 15 |

All Dimension are in mm

**Available in Set of 8**  
**Code # Set - A007**

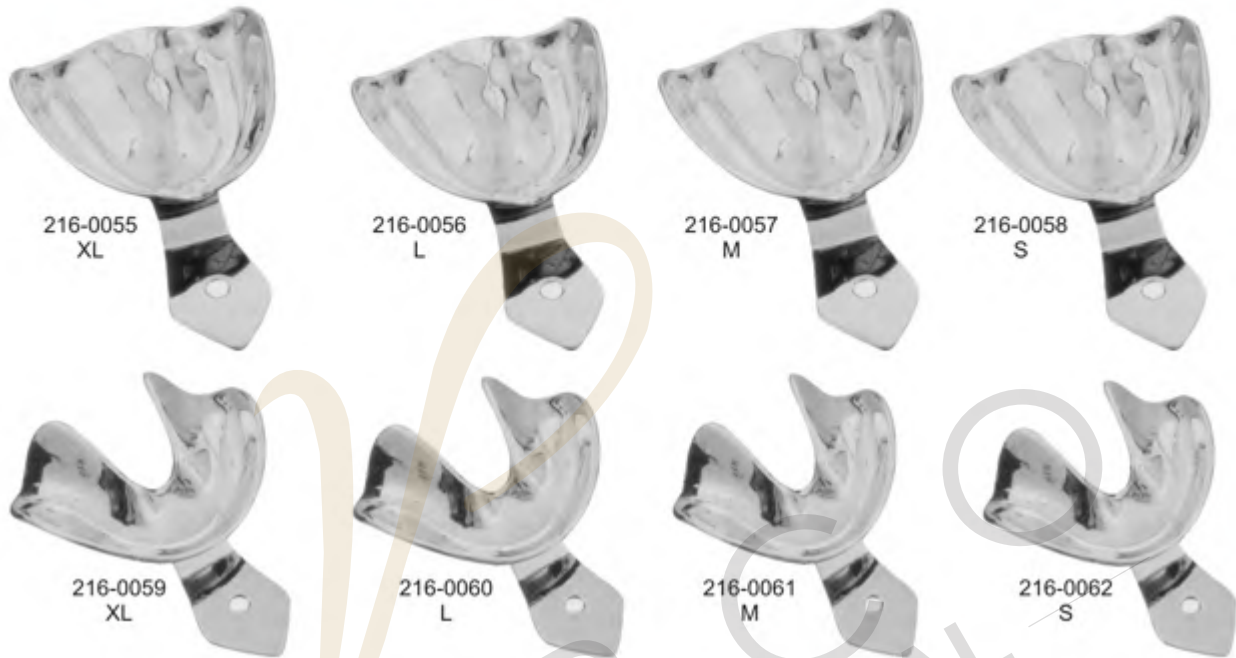

All the above impression trays are available in these 4 sizes

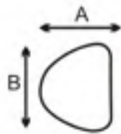

| UPPER |    | XL | L  | M  | S  |
|-------|----|----|----|----|----|
|       | A  | 70 | 67 | 64 | 60 |
| B     | 79 | 78 | 70 | 73 |    |

All Dimension are in mm

| LOWER |    | XL | L  | M  | S  |
|-------|----|----|----|----|----|
|       | A  | 64 | 64 | 60 | 57 |
| B     | 86 | 70 | 73 | 70 |    |

All Dimension are in mm

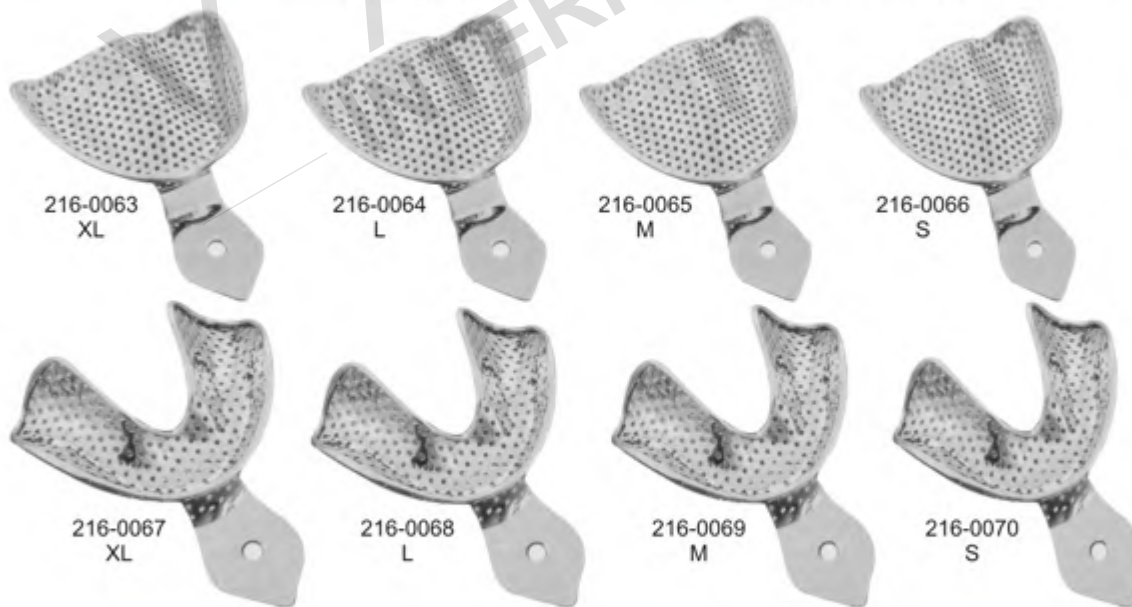
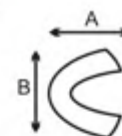

**Available in Set of 8**  
**Code # Set - A008**

●●● IMPRESSION TRAYS

**Available in Set of 8**  
**Code # Set - A009**

For crown & bridgework Impression Trays

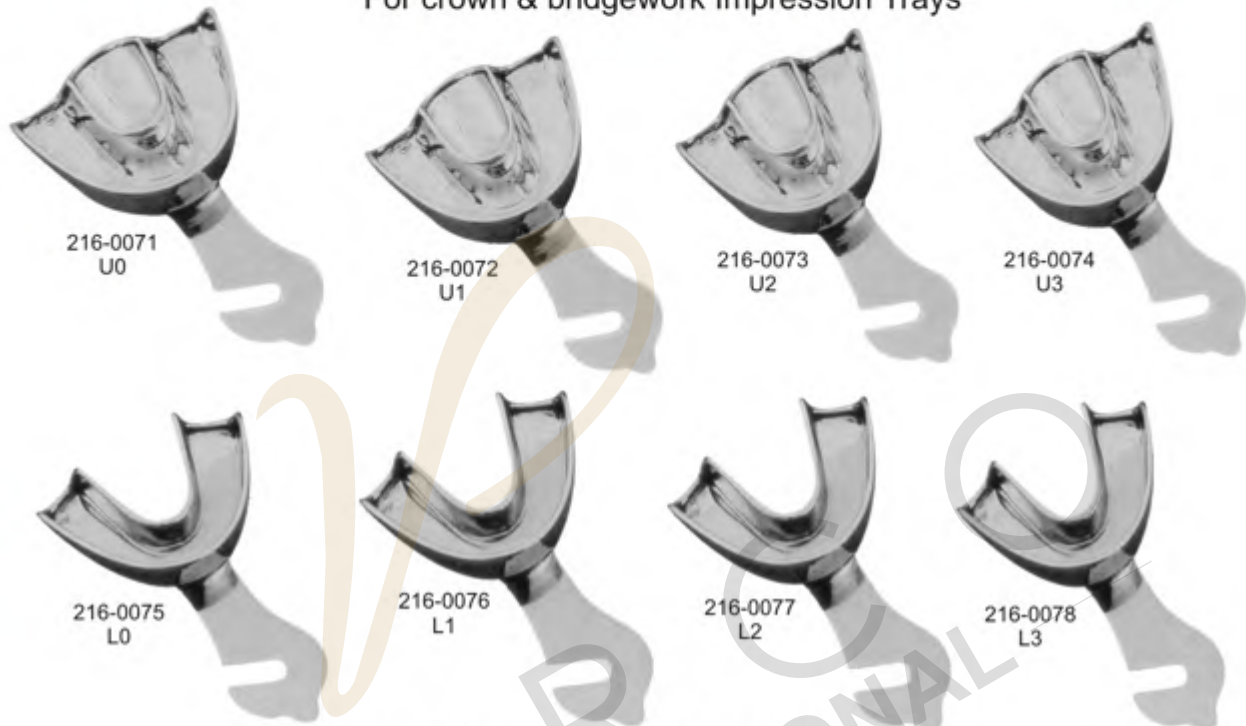

216-0071  
U0

216-0072  
U1

216-0073  
U2

216-0074  
U3

216-0075  
L0

216-0076  
L1

216-0077  
L2

216-0078  
L3

Upper Sizes 0,1,2,3,  
Depth of the tray 19,9 mm  
Height of palate 12,5 mm

Lower Sizes 0,1,2,3,  
Depth of the tray 12,9 mm

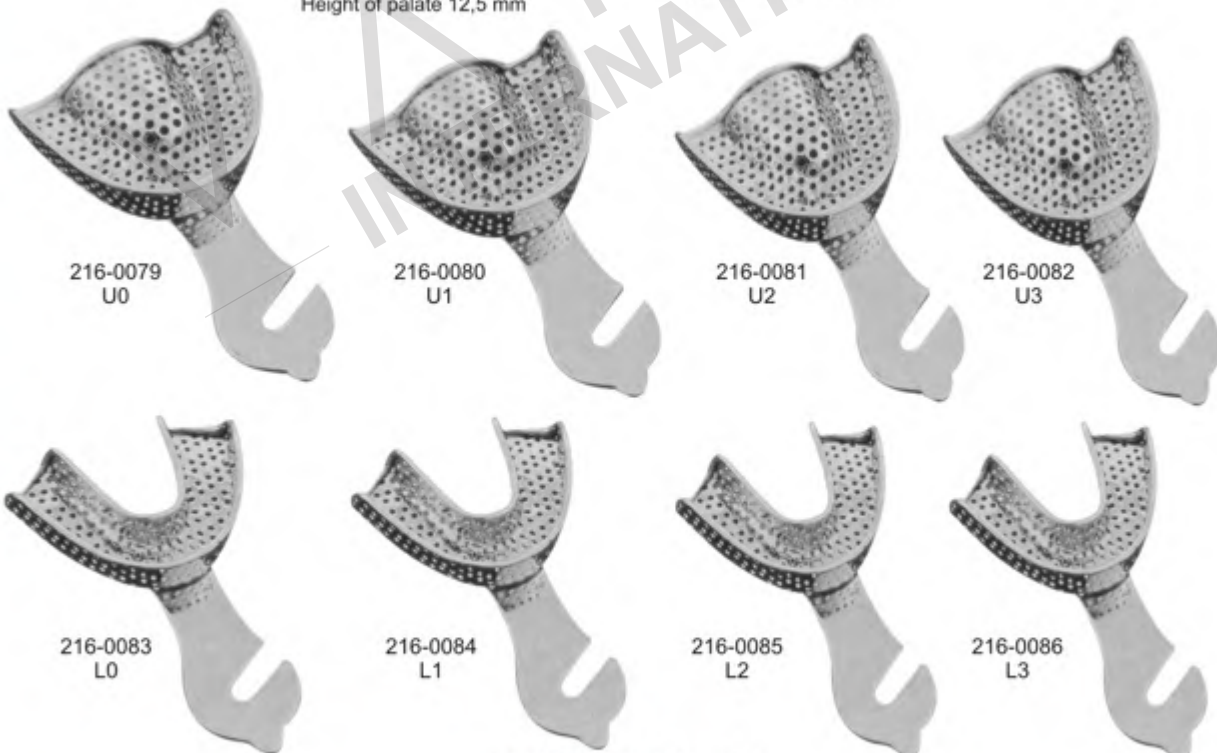

216-0079  
U0

216-0080  
U1

216-0081  
U2

216-0082  
U3

216-0083  
L0

216-0084  
L1

216-0085  
L2

216-0086  
L3

**Available in Set of 8**  
**Code # Set - A010**



Impression trays for crown & bridge work



216-0087  
U1P

Solid

216-0088  
L1P

216-0089  
U1P

Perforated

216-0090  
L1P

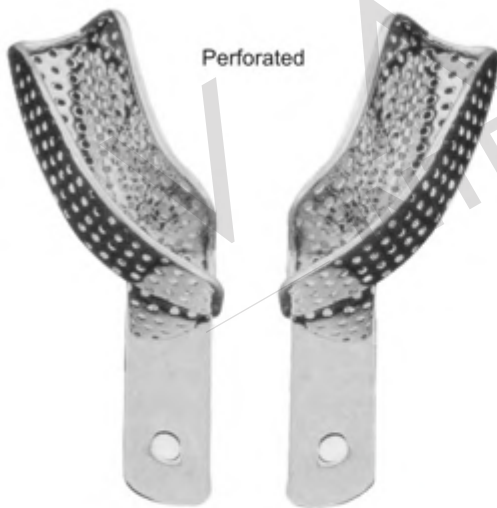

Perforated

216-0091  
For upper right jaw  
For lower left jaw

216-0092  
For upper left jaw  
For lower right jaw



216-0093  
Adjustable  
Perforated



216-0094  
Adjustable  
Solid

Available in 4 Sizes

- 1.....44 mm
- 2.....55 mm
- 3.....60 mm
- 4.....65 mm

Also available in Solid pattern

## ●●● INSTRUMENTS TRAYS

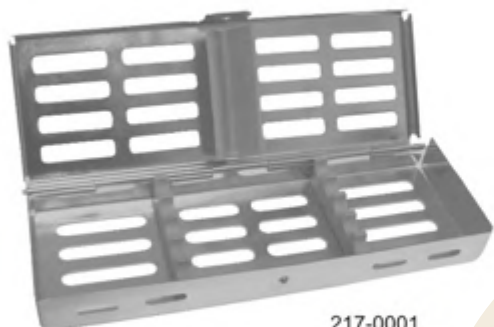

217-0001  
Scaler Sterilizing Tray  
For 5-pcs  
18 x 6 x 2 cm



217-0002  
Scaler Sterilizing Tray  
For 5-pcs  
18 x 8.5 x 2 cm

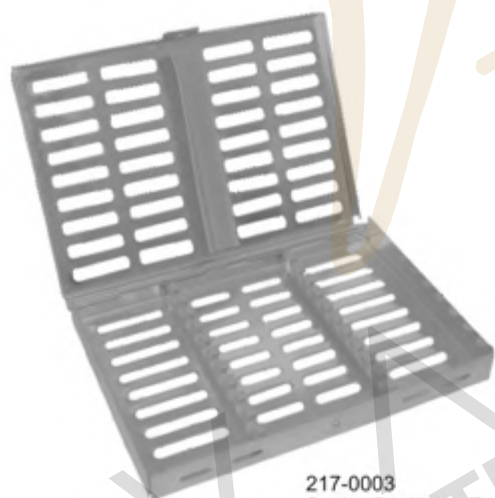

217-0003  
Scaler Sterilizing Tray  
For 10-pcs  
18 x 12.5 x 2 cm



217-0004  
Scaler Sterilizing Tray  
For 10-pcs  
18 x 14 x 2 cm

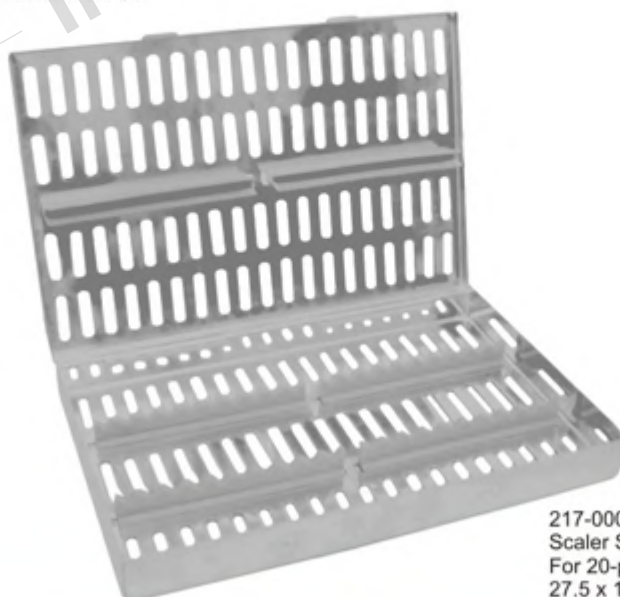

217-0005  
Scaler Sterilizing Tray  
For 20-pcs  
27.5 x 18 x 2.5 cm

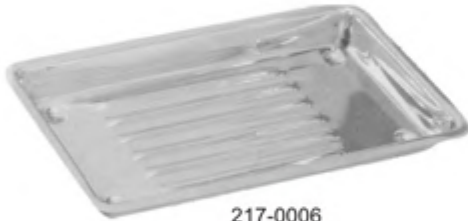

217-0006  
Scallers Tray



Instruments Box

- 217-0007  
10"×6"×2"
- 217-0008  
12"×8"×2½"
- 217-0009  
16"×12"×4"

- 217-0010  
8"×6"×2"
- 217-0011  
10"×8"×2"
- 217-0012  
12"×8"×2½"
- 217-0013  
12"×10"×2½"
- 217-0014  
14"×10"×2½"
- 217-0015  
14"×12"×2½"



Instruments Tray with Lid



Instruments Tray without Lid

- 217-0016  
8"×6"×2"
- 217-0017  
10"×8"×2"
- 217-0018  
12"×8"×2½"
- 217-0019  
12"×10"×2½"
- 217-0020  
14"×10"×2½"
- 217-0021  
14"×12"×2½"

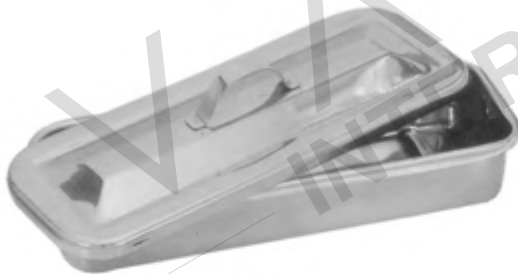

217-0022  
8"×3"×1½"  
Instruments Box



217-0023  
Endodontic box

- 217-0024  
10"×6"×2"
- 217-0025  
12"×8"×2½"
- 217-0026  
16"×12"×4"



Instruments Box

## ●●● HOLLOW WARE ITEMS

|          | Ø   | Depth |
|----------|-----|-------|
| 217-0027 | 2"  | 2"    |
| 217-0028 | 4"  | 2"    |
| 217-0029 | 5½" | 2½"   |
| 217-0030 | 6"  | 2¾"   |
| 217-0031 | 7"  | 3½"   |
| 217-0032 | 8"  | 3½"   |
| 217-0033 | 10" | 4"    |



Lotion Bowl



Kidney Trays

|          |     |
|----------|-----|
| 217-0034 | 6"  |
| 217-0035 | 8"  |
| 217-0036 | 10" |
| 217-0037 | 12" |



217-0038  
6"×9"  
Sterilizing Drum  
217-0039  
8"×12"



217-0040  
10"×10"  
Sterilizing Drum



217-0041  
Cotton Holder

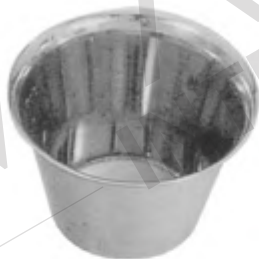

217-0042  
80 × 35 mm  
Medicine Cup  
217-0043  
125 × 60 mm

|          |              |
|----------|--------------|
| 217-0046 | 25 × 80 mm   |
| 217-0047 | 30 × 100 mm  |
| 217-0048 | 75 × 173 mm  |
| 217-0049 | 100 × 200 mm |



217-0044  
Spirit Lamp



217-0045  
Spirit Lamp

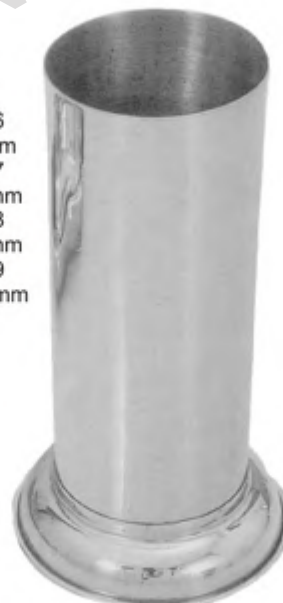

Forcep Jar



217-0050  
5cm×15cm  
Forcep Jar  
217-0051  
5cm×10cm

**Molar Clamps Winged**



218-0001  
Fig. 30



218-0002  
Fig. 31



218-0003  
Fig. 51



218-0004  
Fig. 138



218-0005  
Fig. 139



218-0006  
Fig. 15



218-0007  
Fig. 18



218-0008  
Fig. 24



218-0009  
Fig. 25



218-0010  
Fig. 26



218-0011  
Fig. 28

**Bicuspid Clamps Winged**



218-0012  
Fig. 206



218-0013  
Fig. 207



218-0014  
Fig. 208



218-0015  
Fig. 209



218-0016  
Fig. 22



218-0017  
Fig. 27



218-0018  
Fig. 29

**Molar Clamps Winged**



218-0019  
Fig. 26A



218-0020  
Fig. 28A



218-0021  
Fig. 30A



218-0022  
Fig. 31A



218-0023  
Fig. 51A

**Bicuspid Clamps Winged**



218-0024  
Fig. 27



218-0025  
Fig. 29



218-0026  
Fig. 60

**Molar Clamps Winged**



218-0027  
Fig. 200



218-0028  
Fig. 201



218-0029  
Fig. 202



218-0030  
Fig. 203



218-0031  
Fig. 204



218-0032  
Fig. 205

**Labial Clamps Winged**



218-0033  
Fig. 210



218-0034  
Fig. 211



218-0035  
Fig. 212

## ●●● ARTICULATOR



219-0001



219-0002



219-0003



219-0004



219-0005



219-0006









220-0007



220-0008



220-0009



220-0010



220-0011



220-0012



220-0013



220-0014



220-0015

## ●●● INSTRUMENTS PACKINGS



220-0016



220-0017

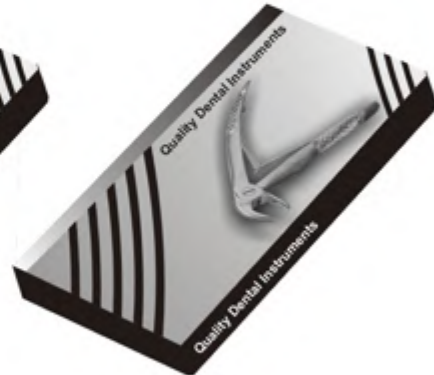

220-0018

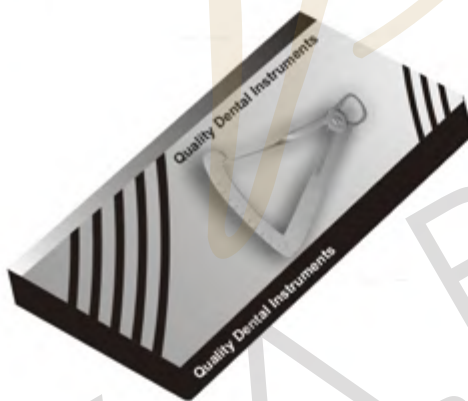

220-0019



220-0020



220-0021



220-0022



220-0023



*High Quality  
Instruments*

Extraction Sets  
Extracting Forceps  
Root Elevators  
Bone Rongeurs  
Orthodontic Pliers  
Scalers  
Impression Trays



**DENTAL**  
*INSTRUMENTS*

